

# CHEST, CUPBOARD & DRAWER LOCKS

Also be sure to check "DESK LOCKS" on pages 291-292 if you cannot find it here.

## SPECIAL PURPOSE DRAWER & DOOR LOCK

**CompX**  
CHICAGO

- Six disc tumbler plug in 3/4" diameter.
- Die Cast barrel with two flats—21/32" across.
- Key and cam rotation 90° from locked (12 O'clock) to unlocked (3 O'clock) position with keypull in both positions.
- This lock designed to be used with customer's latching mechanism.
- Standard finish: Satin Nickel.
- Two keys furnished per lock.

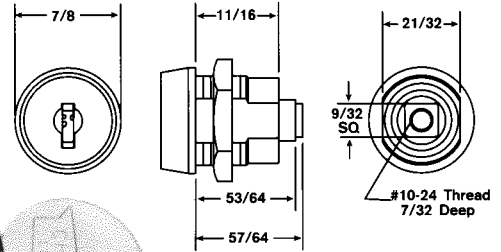
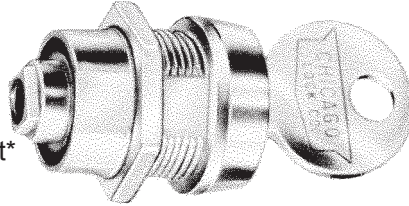

**Stock No.**  
**C17256TNH KV\***

**Keying**  
Keyed Different\*

\*KV indicates the majority of the quantity of locks will be keyed different. A lesser quantity will potentially be keyed alike to one or more key numbers. We can not guarantee that we can ship keyed DIFFERENT locks.

## BOLT TYPE LOCKS

- Five Disc tumbler.
- Removable plug feature.
- Steel locking bolt.
- Furnished with two keys per lock.

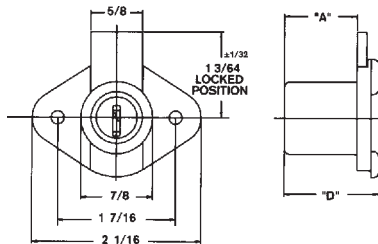

**C1968**

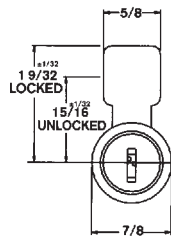

**C1975**

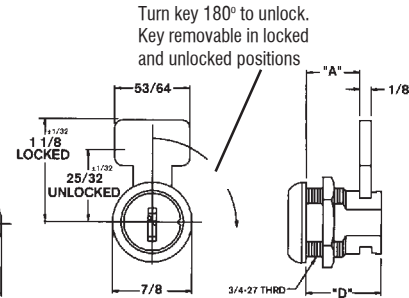

**C1974**

Stock No.	A	D	Finish	Keyed Alike Numbers Available
<b>C1968</b>	57/64"	1-5/32"	Brushed Brass	1289, 1454
<b>C1974</b>	19/32"	27/32"	Satin Chrome	1289
<b>C1975</b>	21/32"	57/64"	Satin Chrome	1289, 1454

Available KV-Keyed Different or KA-Keyed Alike. **Specify KV or KA**

\*KV indicates the majority of the quantity of locks will be keyed different. A lesser quantity will potentially be keyed alike to one or more key numbers. We can not guarantee that we can ship keyed DIFFERENT locks.

**Need a Chicago item not shown?  
Contact us with your needs.**

©ZIPF LOCK COMPANY

SUPER SPECIAL PRICING AVAILABLE ON ITEMS MARKED WITH ■ - SUPPLIES LIMITED - PLEASE INQUIRE.

**259**<sub>v1</sub>  
(PL-20)

# CHEST, CUPBOARD & DRAWER LOCKS

Also be sure to check "DESK LOCKS" on pages 291-292 if you cannot find it here.

## 23000 SERIES SINGLE BITTED DRAWER LOCKS W/UNIVERSAL KEYWAY

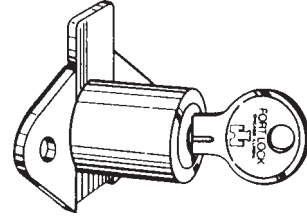

- Single bitted.
- Universal Keyway—K54G. (See next page)
- Multi-function—Latch & Deadlatch included.
- Keypull at 12:00 & 3:00.
- Finish: Brass or Stainless Steel.
- Two keys furnished per lock.

Stock No.	Finish	Barrel Length	Keyed Alike Numbers Available
<b>MFW-23007</b>	Stainless Steel	7/8"	221
<b>MFW-23007B</b>	Brass	7/8"	

Available **KD**-Keyed Different or **KA**-Keyed Alike. *Specify KD or KA*

## 23000 SERIES MULTI-FUNCTION METAL DRAWER LOCK w/UNIVERSAL KEYWAY

- Single bitted.
- Multi-function—2 bolt throw heights.
- Bolt notched for assembled installation.
- 90° key turn to open.
- Key removable locked or unlocked.
- Removable cylinder for rekeying.
- Finish: Brass or Stainless Steel.
- Two keys furnished per lock.

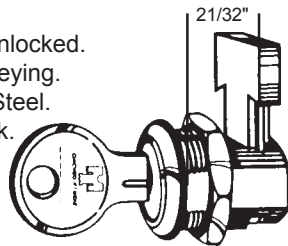

Stock No	Keying
<b>MFW-23010 KD</b>	Keyed Different
<b>MFW-23010 KA</b>	Keyed Alike—217, 237

## 1000 SERIES HIGH SECURITY TUBULAR DRAWER LOCK

- 7 pin tumbler.
- 3/8" bolt throw.
- Keypulls at 12:00 & 6:00.
- 180° key turn to open
- Standard finish: Chrome Plated.
- Two keys furnished per lock.

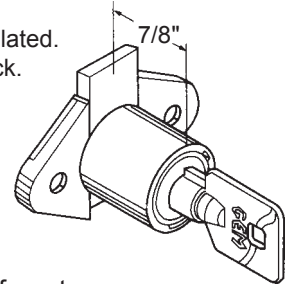

Discontinued. Call for closeout prices.

Stock No	Keying
<b>DR-1008 KD</b>	Keyed Different
<b>DR-1008 KA</b>	Keyed Alike—27379, 27380

## DRAWER AND CABINET LOCKS

- Single bitted.
- Key removable at 12:00 & 6:00.
- Keyway: O1014S.
- 7/8" diameter.
- Brass finish.

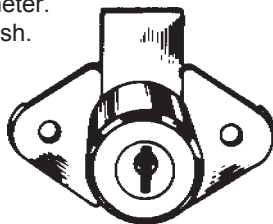

Stock No.	Barrel Length	Keyed Alike Number Available
<b>1701-04-11</b>	3/4"	
<b>1702-04-11</b>	7/8"	<b>EB8</b> , EB72, EB78, EB92

Available **KD**-Keyed Different or **KA**-Keyed Alike.

*Specify KV or KA*

©ZIPF LOCK COMPANY

**260**<sub>v2</sub>  
(PL-20)

SUPER SPECIAL PRICING AVAILABLE ON ITEMS MARKED WITH ■ - SUPPLIES LIMITED - PLEASE INQUIRE.

# CHEST, CUPBOARD & DRAWER LOCKS

Also be sure to check "DESK LOCKS" on pages 291-292 if you cannot find it here.

## PIN TUMBLER DOOR AND DRAWER LOCKS

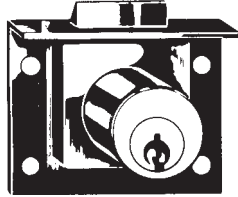

NL-C8131

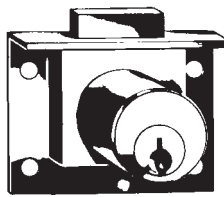
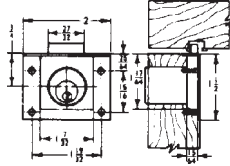

NL-C8133  
NL-C8135

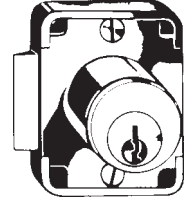
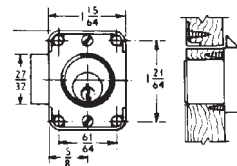

NL-C8139

**APPLICATION**—For drawers. Half mortise type requires mortise for housing and 57/64" dia. hole for cylinder. NL-C8139 is surface mounted.

**OPERATION**—Key removable in both locked and unlocked positions except NL-C8131 and NL-C8139.

**KEYING**—Will key together with all other pin tumbler locks using D4291 key blank except NL-C8700 mail box locks. Available keyed different (**KD**) or keyed alike (**KA**).

**KEY BLANK**—D4291.

**PACKAGING**—Supplied with two keys, strike and mounting screws.

**FINISHES**—4-Satin Brass, 26D- Dull Chrome.

Stock #	Installation	Bolt Type	Cylinder Length	Bolt Travel	Keyed Alike Numbers Available
NL-C8131-4*	Drawer	Spring	7/8"	7/32"	107
NL-C8131-26D*	Drawer	Spring	7/8"	7/32"	107
NL-C8133-4	Drawer	Dead	7/8"	1/4"	107
NL-C8133-26D	Drawer	Dead	7/8"	1/4"	101, 107
NL-C8135-26D	Drawer	Dead	1-1/8"	1/4"	101, 107
NL-C8139-26D*	Door	Spring	3/4"	7/32"	915

\*Key removable in locked position only.

Available **KD**-Keyed Different or **KA**-Keyed Alike. *Specify KD or KA*

## PIN TUMBLER DOOR DRAWER LOCKS

**APPLICATION**—For center drawers of desks. Fits special piercing of drawer front and selvage (see drawing). Reinforced insertable dead bolt. Metal drawer, 1/4" Max. material thickness.

**OPERATION**—Key removable in both locked and unlocked positions.

**KEYING**—Will key together with all other pin tumbler locks using D4291 key blank except NL-C8700 mail box locks. Available keyed different (**KD**) or keyed alike (**KA**).

**KEY BLANK**—D4291.

**PACKAGING**—Supplied with two keys and mounting nut.

**FINISHES**—26D- Dull Chrome.

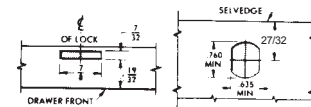

Mounting Holes



Stock #	Mounting or Installation	Bolt Type	Cylinder Length	Bolt Travel	Keyed Alike Number Available
NL-C8137-26D	Drawer	Reinforced, Insertable Dead Bolt	19/32"	7/16"	107, 915

Available **KD**-Keyed Different or **KA**-Keyed Alike. *Specify KD or KA*

©ZIPF LOCK COMPANY

SUPER SPECIAL PRICING AVAILABLE ON ITEMS MARKED WITH ■ - SUPPLIES LIMITED - PLEASE INQUIRE.

261<sup>v1</sup>  
(PL-20)

# CHEST, CUPBOARD & DRAWER LOCKS

Also be sure to check "DESK LOCKS" on pages 291-292 if you cannot find it here.

## PIN TUMBLER DOOR AND DRAWER LOCKS



**APPLICATION**—For drawers, RH or LH doors. Surface mounted. Requires 57/64" dia. hole for cylinder.

**OPERATION**—Key removable in both locked and unlocked positions.

**KEYING**—Will key together with all other pin tumbler locks using D4291 key blank except NL-C8700 mail box locks. Available keyed different (**KD**) or keyed alike (**KA**).

**KEY BLANK**—D4291.

**PACKAGING**—Supplied with two keys, strike and mounting screws.

**FINISHES**—4-Satin Brass, 4G-Antique Brass, 26D- Dull Chrome.

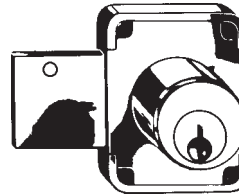
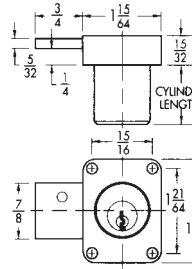

NL-C8173, NL-C8174, NL-C8175

## "The Advantage Plus"

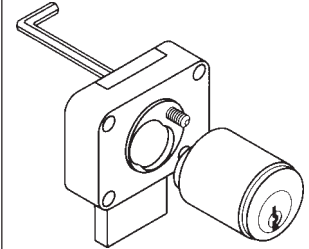

The PLUS feature allows you to remove the cylinder from these pin tumbler box locks while the lock remains in place. Simply use a 5/64" allen wrench from the back.

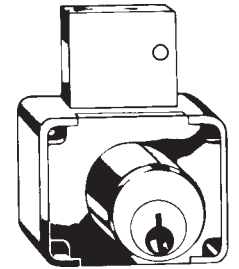
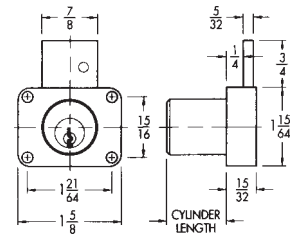

NL-C8177, NL-C8178, NL-C8179

Stock No.	Installation	Bolt Type	Cylinder Length	Bolt Travel	Keyed Alike Numbers Available
NL-C8173-4	Door	Dead	7/8"	3/4"	915
NL-C8173-4G	Door	Dead	7/8"	3/4"	915
NL-C8173-26D	Door	Dead	7/8"	3/4"	107, 915
NL-C8174-26D	Door	Dead	1-1/8"	3/4"	107
NL-C8175-26D	Door	Dead	1-3/8"	3/4"	107
NL-C8177-26D	Drawer	Dead	1-1/8"	3/4"	107
NL-C8178-4	Drawer	Dead	7/8"	3/4"	
NL-C8178-26D	Drawer	Dead	7/8"	3/4"	103, 915
NL-C8179-26D	Drawer	Dead	1-3/8"	3/4"	915

Available **KD**-Keyed Different or **KA**-Keyed Alike. *Specify KD or KA*

## PIN TUMBLER DRAWER LOCKS

**APPLICATION**—For drawers. Surface mounted. Requires 57/64" dia. hole for cylinder.

**OPERATION**—Key removable in both locked and unlocked positions.

**KEYING**—Will key together with all other pin tumbler locks using D4291 key blank except NL-C8700 mail box locks. Available keyed different (**KD**) or keyed alike (**KA**).

**KEY BLANK**—D4291.

**PACKAGING**—Supplied with two keys and mounting screws.

**FINISHES**—4-Satin Brass, 26D- Dull Chrome.

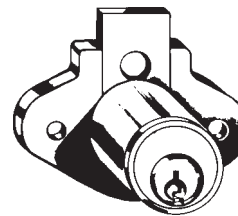

NL-C8163

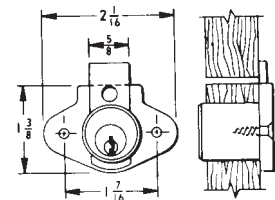

Stock No.	Installation	Bolt Type	Cylinder Length	Bolt Travel	Keyed Alike Number Avail.
NL-C8163-4	Drawer	Dead	15/16"	11/32"	101, 103, 107
NL-C8163-26D	Drawer	Dead	15/16"	11/32"	101, 915

Available **KD**-Keyed Different or **KA**-Keyed Alike. *Specify KD or KA*

"THE ADVANTAGE PLUS" NL-C8163 locks feature easy removal of cylinder from lock housing while lock remains in place. Bolt has access hole for cylinder retention screw at back of lock.

©ZIPF LOCK COMPANY

# CHEST, CUPBOARD & DRAWER LOCKS

Also be sure to check "DESK LOCKS" on pages 291-292 if you cannot find it here.

## PIN TUMBLER DRAWER LOCKS

**APPLICATION**—Replacement lock housing and cylinder for drawers with 7/8" thick fronts. Half mortise design.

**OPERATION**—Key removable in both locked and unlocked positions. Interchangeable cylinders are attached or removed through the use of a special key at back of lock.

**KEYING**—Keyed different (KD). 100 changes.

**KEY BLANK**—D4292 for the NL-C8160.

**PACKAGING**—NL-C8160 cylinder supplied with two keys. NL-C8161 lock housing supplied with cylinder removal key and mounting screws.

**FINISHES**—26-Bright Brass; 26D- Dull Chrome.

CompX  
NATIONAL

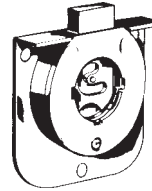

NL-C8161

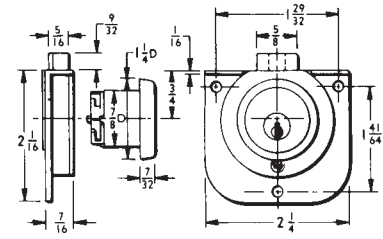

NL-C8160

Stock #	Mounting or Installation	Bolt Type	Min. Material Thickness	Bolt Travel	Keyed Alike Numbers Available
NL-C8160-26D	In Housing	—	—	—	—
NL-C8161-26	Drawer	Dead	7/8"	9/32"	—

## DISC TUMBLER DRAWER LOCKS

**APPLICATION**—For center drawers of metal desks. Fits special piercing of drawer front and selvage (see drawing). 1/4" max. mat'l. thickness

**OPERATION**—Key removable in both locked and unlocked positions.

**KEYING**—Will key together with all other disc tumbler locks using D8785 key blank. Available keyed different (KD) or keyed alike (KA).

**KEY BLANK**—D8785.

**PACKAGING**—Supplied with two keys and mounting nut.

**FINISHES**—14A- Bright Nickel

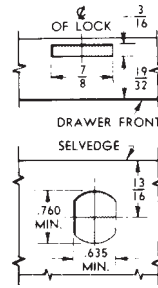

Stock #	Mounting or Installation	Bolt Type	Cylinder Length	Bolt Travel	Keyed Alike Numbers Available
NL-C8701-14A	Drawer*	Reinforced, Insertable Dead Bolt	19/32"	11/32"	C413A

\*Metal drawer, 1/4" max. material thickness.

Available KD-Keyed Different or KA-Keyed Alike. Specify KD or KA

©ZIPF LOCK COMPANY

SUPER SPECIAL PRICING AVAILABLE ON ITEMS MARKED WITH ■ - SUPPLIES LIMITED - PLEASE INQUIRE.

263<sub>v1</sub>  
(PL-20)

# CHEST, CUPBOARD & DRAWER LOCKS

Also be sure to check "DESK LOCKS" on pages 291-292 if you cannot find it here.

## DISC TUMBLER DOOR AND DRAWER LOCKS



**APPLICATION**—For drawers and doors. Surface mounted. Requires 7/8" dia. hole for cylinder.

**OPERATION**—Key removable in both locked and unlocked positions, except NL-C8706.

**KEYING**—Will key together with all other disc tumbler locks using D8785 key blank. Available keyed different (**KD**) or keyed alike (**KA**).

**KEY BLANK**—D8785.

**PACKAGING**—Supplied with two keys and mounting screws(NL-C8706 furnished with strike).

**FINISHES**—**3**-Bright Brass, **4G**-Antique Brass, **14A**- Bright Nickel.

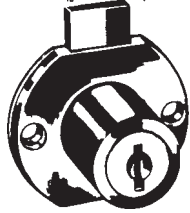
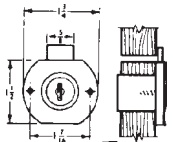

NL-C8703  
NL-C8705

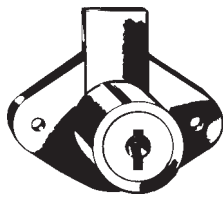
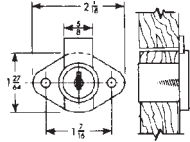

NL-C8803

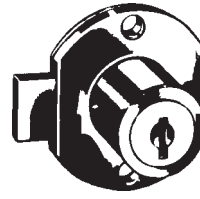
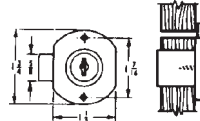

NL-C8704

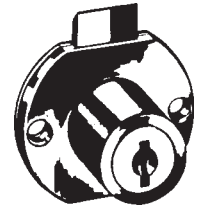
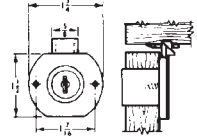

NL-C8706

Stock #	Installation	Bolt Type	Cylinder Length	Bolt Travel	Keyed Alike Numbers Available
NL-C8703-3	Drawer	Dead	15/16"	11/32"	C346A, C413A, C415A, C420A, C642A
NL-C8703-4G	Drawer	Dead	15/16"	11/32"	C346A, C642A
NL-C8703-14A	Drawer	Dead	15/16"	11/32"	C346A, C415A, C420A, C642A
NL-C8704-3	Door	Dead	15/16"	11/32"	C413A, C415A, C642A
NL-C8704-4G	Door	Dead	15/16"	11/32"	C642A
NL-C8704-14A	Door	Dead	15/16"	11/32"	C415A, C642A
NL-C8705-3	Drawer	Dead	1-3/16"	11/32"	C413A, C415A
NL-C8705-4G	Drawer	Dead	1-3/16"	11/32"	C413A, C415A
NL-C8705-14A	Drawer	Dead	1-3/16"	11/32"	
NL-C8706-3	Drawer	Spring	15/16"	9/32"	C413A, C415A
NL-C8803-3	Drawer	Dead	15/16"	11/32"	C346A, C390A, C413A, C415A
NL-C8803-4G	Drawer	Dead	15/16"	11/32"	
NL-C8803-14A	Drawer	Dead	15/16"	11/32"	C415A, C420A

Available **KD**-Keyed Different or **KA**-Keyed Alike. *Specify KD or KA*

# CHEST, CUPBOARD & DRAWER LOCKS

Also be sure to check "DESK LOCKS" on pages 291-292 if you cannot find it here.

## FURNITURE LOCKS

CompX  
NATIONAL

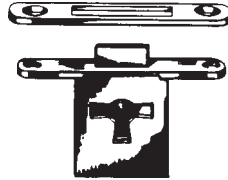
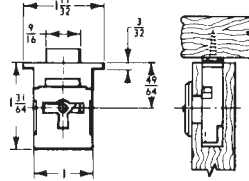
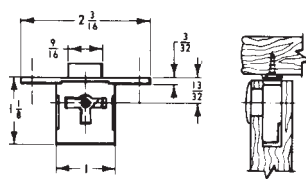

NL-C8252-3  
NL-C8253-3

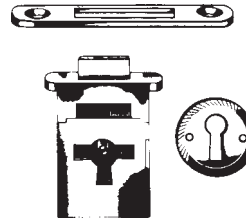

NL-C8207-3

**APPLICATION**—This group of locks is used primarily on furniture and other fine cabinetry. Additional mortising required for lock selvage plus hole for key entry.

**OPERATION**—Key removable in both locked and unlocked positions.

**KEYING**—Each lock furnished **keyed alike**.

**KEY BLANK**—D8890.

**PACKAGING**—Supplied with one key. All locks except NL-C8826 are supplied with strikes. Key hole escutcheons are packed with NL-C8207.

**FINISHES**—3-Bright Brass.

Stock No.	Installation	Bolt Type	Bolt Travel
NL-C8207-3	R.H. Door, Drawer	Dead	3/16"
NL-C8252-3	Full Mortise	Dead	3/16"
NL-C8253-3	L.H. Door, Full Mortise	Dead	3/16"

## CHEST/LID LOCKS

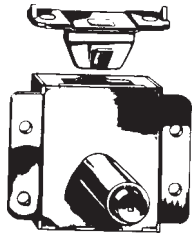
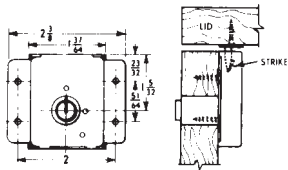

NL-C8412-4G

**APPLICATION**—Lid locks for cedar chest application and other lid locking requirements. NL-C8414 is surface mounted and requires a 9/16" dia. hole for cylinder.

**OPERATION**—Key removable in both locked and unlocked positions. NL-C8414 has a safety feature requiring operation of pushbutton to lock or latch lid closed.

**KEYING**—Each lock furnished **keyed alike**.

**KEY BLANK**—D8191 for NL-C8412.

**PACKAGING**—Supplied with one key. Appropriate strikes and mounting screws supplied with locks.

**FINISHES**—3-Bright Brass, 4G-Antique Brass.

Stock #	Installation	Bolt Type	Cylinder Length	Bolt Travel
NL-C8412-4G	Chest lid, Surface Mounted	Internal Engages Strike	7/8"	—

©ZIPF LOCK COMPANY

SUPER SPECIAL PRICING AVAILABLE ON ITEMS MARKED WITH ■ - SUPPLIES LIMITED - PLEASE INQUIRE.

265<sup>v1</sup>  
(PL-20)

# CHEST, CUPBOARD & DRAWER LOCKS

Also be sure to check "DESK LOCKS" on pages 291-292 if you cannot find it here.



All Timberline Locks consist of two separate components: a lock plug and a cylinder body. A change tool (TB-D500KY) is required to remove lock plugs from the cylinder bodies.

## REMOVABLE LOCK PLUG SYSTEM

- Wide selection of locks to fit most furniture & cabinet applications.
- Available in several high quality finishes.
- Removable lock plugs for complete keying versatility.
- Prepackaged in poly-bags for easy distribution to your customer.

**These lock plugs will fit in ALL Timberline Locks**

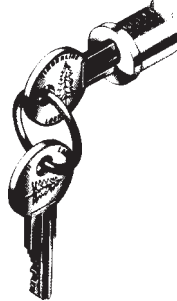

<b>Stock No.</b>	<b>Finish</b>
<b>TB-C100LP-14A</b>	Polished Nickel
<b>TB-C200LP-8</b>	Old English
<b>TB-C300LP-19</b>	Black
<b>TB-C400LP-20</b>	Statuary Bronze
<b>TB-C500LP3</b>	Polished Brass
Available Keyed Different (KD) or Keyed Alike (KA): 100T or 105T	

## DOOR LOCKS



**TB-C240CB**

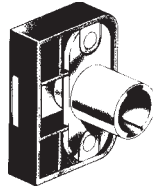

**TB-C290CB**

**APPLICATION**—Surface mounted lock for locking doors.  
**OPERATION**—180° key rotation, CCW to lock, key removable in both locked and unlocked positions.  
**KEYING**—Order lock plug separately. (See above)  
**PACKAGING**—Housing is black, toughened nylon. Cylinder is unplated. Cams are zinc plated.

Stock No.	Cam Setback	Cam Extension*	Cam Throw
<b>TB-C240CB</b>	3/32"	15/16"	1/2"
<b>TB-C290CB</b>	9/32"	13/16"	3/8"

\*Measured from center of cylinder to tip of cam in unlocked position.

## DRAWER LOCKS

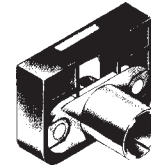

**TB-C280CB**

**APPLICATION**—Surface mounted lock for locking drawers.  
**OPERATION**—180° key rotation, CCW to lock, key removable in both locked and unlocked positions.  
**KEYING**—Order lock plug separately. (See above)  
**PACKAGING**—Housing is black, toughened nylon. Cylinder is unplated. Cams are zinc plated.

Stock No.	Cam Setback	Cam Extension*	Cam Throw
<b>TB-C280CB</b>	9/32"	13/16"	3/8"

\*Measured from center of cylinder to tip of cam in unlocked position.

## CAM LOCK KIT—TB-C165CB

**APPLICATION**—Universal type lock for either doors or drawers. Kit contains a variety of easily switched cams to accommodate most locking situations.  
**OPERATION**—90° key rotation, CCW to lock.  
**KEYING**—Order lock plug separately. (See above)  
**PACKAGING**—Cylinder supplied with two straight cams and two bent cams. Cylinder is unplated. Cams are zinc plated.

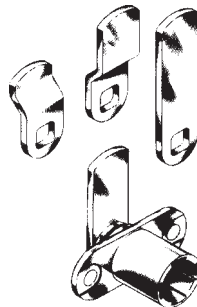

<b>Stock No.</b>	<b>Description</b>
<b>TB-C165CB</b>	Cam Lock Kit

This kit will replace the following Timberline cam locks:

90° Rotation		180° Rotation	
CB-080	CB-090	CB-180	CB-190
CB-083	CB-093	CB-183	CB-193
CB-084	CB-094	CB-184	CB-194
CB-085	CB-095	CB-185	CB-195
CB-087	CB-097	CB-187	CB-197
CB-088	CB-098	CB-188	CB-198

**Need a lock not shown here?? Then just give us a call 1-800-848-1577.**



# CHEST, CUPBOARD & DRAWER LOCKS

Also be sure to check "DESK LOCKS" on pages 291-292 if you cannot find it here.

## TWO DRAWER SIDE GANG LOCK—TB-D270CB

**APPLICATION**—Two drawer gang lock for locking two pedestal drawers with a single lock. Lock mounts on side of cabinet.

**OPERATION**—180° key rotation, CCW to lock. Key removable in both locked and unlocked position.

**KEYING**—Order lock plug separately. (See previous page)

**PACKAGING**—Housing supplied with two C500DC-19 Drawer Clips. Housing is black, toughened nylon. Cylinder is unplated. Cams are zinc plated.

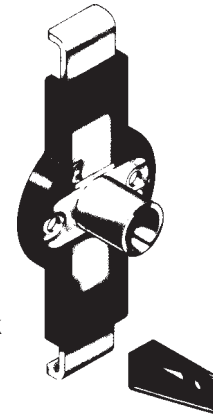

Stock No.  
**TB-D270CB**

Description  
Side Gang Lock

## DOUBLE DOOR LOCKS

**APPLICATION**—Surface mount lock for locking two adjacent doors. Eliminates the need for a spring catch on the door opposite the lock. Works with either overlay or inset doors.

**OPERATION**—180° key rotation, CCW to lock. Key removable in both locked and unlocked position.

**KEYING**—Order lock plug separately. (See previous page)

**PACKAGING**—Supplied with two strike plates as shown. Housing is black, toughened nylon. Cylinder is unplated. Cams are zinc plated.

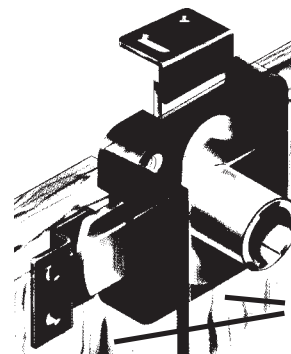

Stock No.  
**TB-C250CB**

Description  
Double Door Lock

Top Cam Setback: 3/16"

Top Cam Extension\*: 29/32"

Side Cam Setback: 3/32"

Side Cam Extension\*: 29/32"

Cam Throw: 1/2"

\*Measured from center of cylinder to tip of cam in unlocked position.

*Locks both doors without the use of a spring catch.*

## THICK PANEL LOCK

**APPLICATION**—Universal type lock for either doors or drawers that can accommodate panel thickness from 7/8" to 1-3/8" thick.

**OPERATION**—90° key rotation, CCW to lock.

**KEYING**—Order lock plug separately. (See previous page)

**PACKAGING**—Housing supplied with straight cam and bent cam. Housings are unplated. Cams are zinc plated.

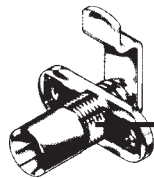

Stock No.  
**TB-C170CB**

Description  
Thick Panel Lock

*Mounting flange adjust to allow lock to be mounted in panels from 7/8" thick up to 1-3/8" thick.*

## PUSH LOCK

**APPLICATION**—For locking sliding, bypass type doors. Requires 3/4" hole in front door for cylinder.

**OPERATION**—Pushing in cylinder locks doors, with or without key. 45° key rotation allows cylinder to pop back out to unlock doors. Key removable in both locked and unlocked positions.

**KEYING**—Order lock plug separately. (See previous page)

**PACKAGING**—Supplied with nickel plated finished cup as shown. Housing is black, toughened nylon.

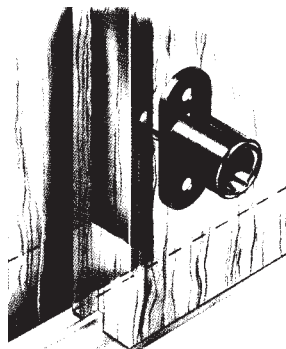

Stock No.  
**TB-C175CB**

Description  
Push Lock

©ZIPF LOCK COMPANY

SUPER SPECIAL PRICING AVAILABLE ON ITEMS MARKED WITH ■ - SUPPLIES LIMITED - PLEASE INQUIRE.

267<sub>v2</sub>  
(PL-20)

# CHEST, CUPBOARD & DRAWER LOCKS

Also be sure to check "DESK LOCKS" on pages 291-292 if you cannot find it here.



## GANG LOCK CYLINDER BODY

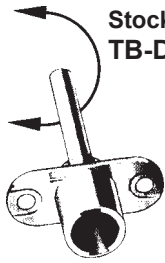

**Stock No.**  
TB-D100CB      **Description**  
For Front Mount Systems

See previous page  
for lock plugs.

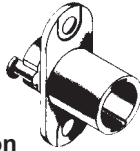

**Stock No.**  
TB-D150CB      **Description**  
For Side Mount Systems

## BEZELS

Allows cylinder bodies to be used with 3/4" through 7/8" diameter holes and permits use of locks in 7/8" thick panels.



**Stock No.**  
TB-C100BZ-14A      **Finish**  
TB-C200BZ-8      Bezel Nickel  
TB-C300BZ-19      Bezel Old English  
TB-C400BZ-20      Bezel Black  
TB-C500BZ-3      Bezel Statuary Bronze  
Bezel Brass

## STRIKE PLATES



TB-C100SP-19



TB-C101SP-19

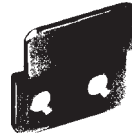

TB-C257SP-19

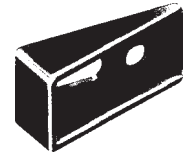

TB-C500DC-19



TB-C185SP-19

## TOOLS



**TB-C165DB**  
16.5mm Drill Bit



**TB-D500KY**  
CHANGE TOOL  
This tool required to remove lock plugs from cylinder bodies.

## T37 T-BOLT DRAWER LOCK - SMALL PIN NATIONAL KEYWAY

### GENERAL FEATURES—

**Rekeyable:** Working top-slide, patented "cylinder retainer staple" and removable bezel ring make rekeying fast and easy. No more need to pry off faceplates and pin retainer clips.

**Retrofits:** National C8137

**Material:** Zinc die cast lock body      **Bolt:** Stainless steel

**Includes:** Brass mounting nut

**Barrel diameter:** 3/4"      **Across flats:** 5/8"

**Cylinder length:** 19/32"      **For material:** 1/4"

**Finish:** 26D

### KEYING INFORMATION—

**Keyway:** National D4291 (4-pin) keyway

**Stock KA#:** 915. *Other KA# by special order.*

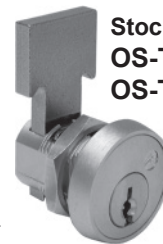

**Stock No.**  
OS-T37-26D-KD  
OS-T37-26D-KA915

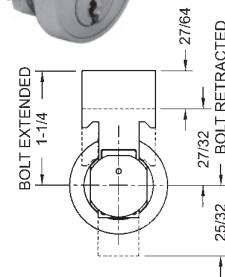
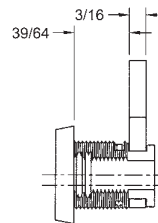
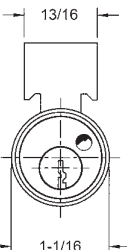
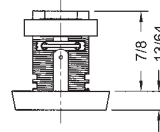

©ZIPF LOCK COMPANY



# CHEST, CUPBOARD & DRAWER LOCKS

Also be sure to check "DESK LOCKS" on pages 291-292 if you cannot find it here.

## 700S / 800S DEADBOLT LOCKS STANDARD CYLINDER-SCHLAGE STYLE

### GENERAL FEATURES—

- Rekeyable:** Easily rekeyable via set screw cylinder release mechanism
  - Certifications:** Passed ANSI/BHMA A156.11 grade 1 cycle testing, obtained grade 2 performance for all other requirements
  - Body:** Zinc die cast lock body
  - Cylinder:** Will accept other manufacturer's Schlage compatible key-in-knob cylinders
  - Barrel lengths:** 7/8" to 1-1/8" adjustable
  - Barrel diameter:** 1-1/8"
  - Finish:** 26D. *Other finishes by special order.*
- ### KEYING INFORMATION—
- Keyway:** Schlage C keyway
  - Cylinder:** Solid brass pin tumbler cylinder
  - Stock keying:** KD/KA - 5 pin standard
  - Stock KA#:** 101. *Other KA# by special order.*

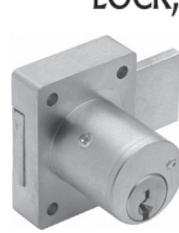

Stock No.  
**OS-700S-26D-KD**  
**OS-700S-26D-KA101**

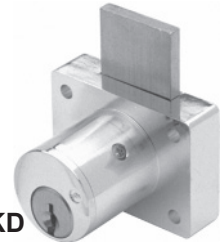

Stock No.  
**OS-800S-26D-KD**  
**OS-800S-26D-KA101**



Includes:  
1/4" plastic bar strike, 1/2" plastic bar strike, 2 plastic spacers (1/8" ea)

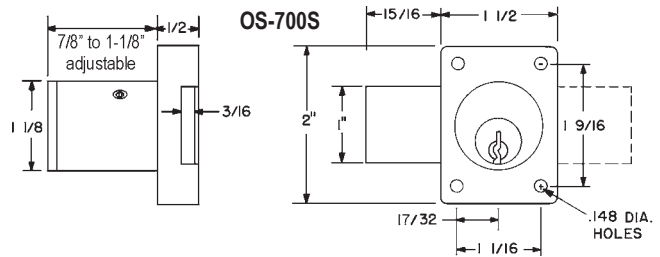
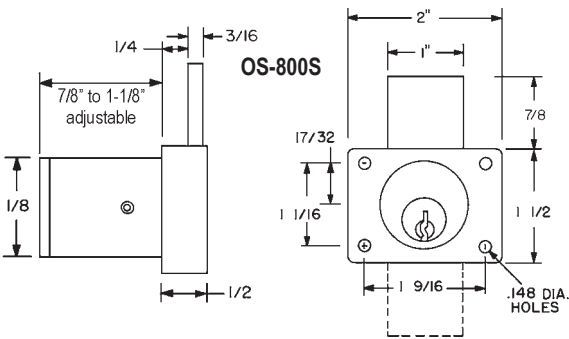

## 721 DEADBOLT LOCK IC CORE-SMALL FORMAT

### GENERAL FEATURES—

- Reversible:** Field reversible between door and drawer functions
  - Certifications:** Passed ANSI/BHMA A156.11 Grade 1 performance requirements
  - Barrel length:** 7/8" to 1-1/4"
  - Barrel diameter:** 1-1/8"
  - Retrofits:** Best 3L
  - Body:** Zinc die cast lock body
  - Finish:** US26. *Other finishes by special order.*
- ### KEYING INFORMATION—
- Cores:** Not included. *Order seperately.*
  - Accepts:** Best, Arrow, Falcon, KSP, Schlage SFIC or equivalent small format interchangeable cores

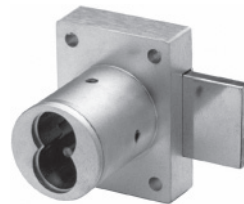

Stock No.  
**OS-721DR-26D**

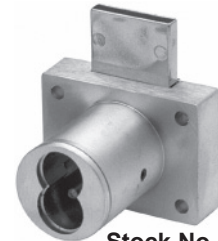

Stock No.  
**OS-721DW-26D**

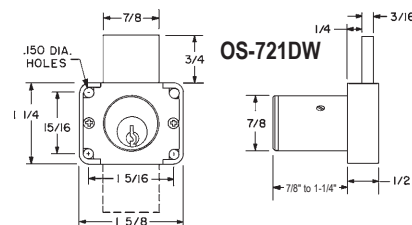
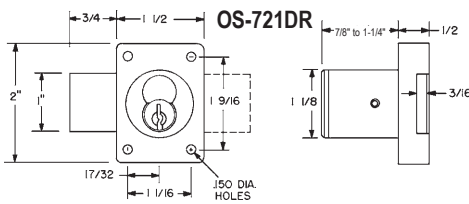
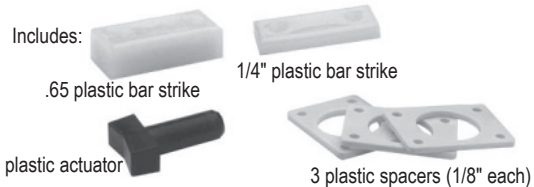

©ZIPF LOCK COMPANY

# CHEST, CUPBOARD & DRAWER LOCKS

Also be sure to check "DESK LOCKS" on pages 291-292 if you cannot find it here.

## 725RD - RIM DEADBOLT (SURFACE) IC CORE - SMALL FORMAT

### GENERAL FEATURES—

**Mounting:** Rim (surface)

**Retrofits:** Best 5L series cabinet lock

**Certifications:** Passed ANSI/BHMA A156.11 Grade 1 performance requirements

**Material:** Zinc die cast cylinder housing, steel back plate and steel case

**Barrel length:** 1-1/16"

**Barrel diameter:** 1-1/8"

**Finish:** US26. *Other finishes by special order.*

### KEYING INFORMATION—

**Cores:** Not included. *Order seperately.*

**Accepts:** Best, Arrow, Falcon, KSP, Schlage SFIC or equivalent small format interchangeable cores

**OLYMPUS**  
LOCK, INC.



**Stock No.**  
**OS-725RD-DW-VH-26D**

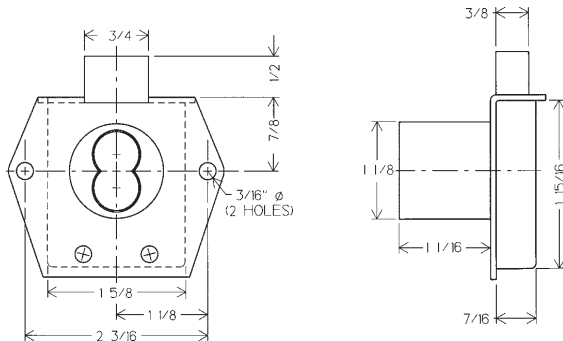

Includes:

  
spacer for  
6 pin cores

  
plastic actuator

  
strike

## 725RL - RIM LATCH (SURFACE) IC CORE - SMALL FORMAT

### GENERAL FEATURES—

**Mounting:** Rim (surface)

**Latch:** for out-swinging door applications.

**Retrofits:** Best 5L series cabinet lock

**Certifications:** Passed ANSI/BHMA A156.11 Grade 1 performance requirements

**Material:** Zinc die cast cylinder housing, steel back plate and steel case

**Barrel length:** 1-1/16"

**Barrel diameter:** 1-1/8"

**Finish:** US26. *Other finishes by special order.*

### KEYING INFORMATION—

**Cores:** Not included. *Order seperately.*

**Accepts:** Best, Arrow, Falcon, KSP, Schlage SFIC or equivalent small format interchangeable cores

**OLYMPUS**  
LOCK, INC.



**Stock No.**  
**OS-725RL-DW-VH-26D**

Includes:

  
spacer for  
6 pin cores

  
plastic actuator

  
strike

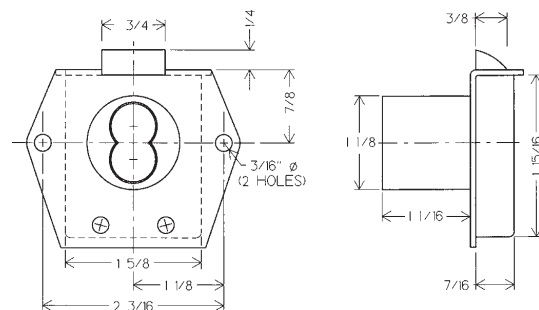

## SMALL FORMAT CORES

**Stock No.**      **Length**  
**AR-100CR-UC**    6 pin  
**AR-7100CR-UC**   7 pin

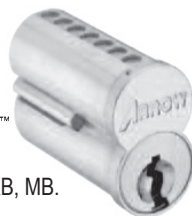

**Keyways:** 1D, AB, BB, DB, EB, FB, GB, HB, JB, KB, MB.

**Finishes:** 4-Satin Brass, 26D-Satin Chrome

**To Order, Specify:**

Stock No. Keyway and Finish (AR-C6S-UC AB 26D)

**REMEMBER: If you don't see what you need,  
please contact us with your requirements.**

©ZIPF LOCK COMPANY