

# SIMPLEX

## E-PLEX E2000 SERIES ELECTRONIC ACCESS CONTROL

- ANSI/BHMA A156.2, Grade 1 Certified.
- Meets A.D.A. accessibility standard.
- 100 access codes - including user and service levels.
- Cylindrical latch. Metal, vandal-resistant keys.
- Simple to install and maintain. **No wiring.**
- Easy to manage - no software required.
- Non handed - field reversible.
- **2-year warranty from date of installation.**  
**Built-in warranty counter in lock memory.**

# E-PLEX®

# SIMPLEX®



Stock No.	Description
<b>SI-E2031-LL-626-41</b>	No key override
<b>SI-E2031-B-LL-626-41</b>	With key override-Best type I/C
<b>SI-E2031-XS-LL-626-41</b>	With key override-Schlage "C"

### SPECIFICATIONS

<b>DOOR THICK.:</b>	1-3/8" to 2-1/4"
<b>BACKSET:</b>	2-3/4"
<b>THROW:</b>	1/2"
<b>HANDING:</b>	Non-handed, pre-assembled for left hand, easily changed in field
<b>LOCK BODY:</b>	Height 8-15/16" x Width 3-5/16" x Depth 2-13/16"
<b>MINIMUM STILE:</b>	5"
<b>FINISH:</b>	26D Satin Chrome

**Easy to install:** The E-Plex 2000 easily installs on wood or metal doors with ASA 161 door prep. Three through bolts secure the lock to the door. Requires no wiring to or through the door. Eliminates risk of damage from pinched wires that can result in costly callbacks. Rugged and weather-resistant external housing can be mounted outdoors and includes installation gasket.

**Easy to manage:** With the E-Plex 2000 users and locks are easily managed at the door with simple keypad programming. Multiple operation modes include PIN entry, passage and lockout. Passage mode can be activated by authorized user with assign PIN and pre-programmed to re-lock after a certain number of hours. Four authority levels give you control over who has access to various lock functions.

**Easy to use:** The user friendly design is equipped with ADA compliant levers. Programmable user parameters customize the lock to the needs of different access points. Audio and visual indicators notify users when access is granted or denied. User access code length can be set from 4 to 8 digits. Time interval between combination entry and relocks is variable from 2 to 20 seconds. Anti-tamper feature disables the lock after multiple invalid combination entries—set for between 3 to 9 attempts and up to 90 seconds. **3 AA batteries allows for continuous operation up to 100,000 cycles.**

## E-PLEX E5000 SERIES ELECTRONIC ACCESS CONTROL

- ANSI/BHMA A156.2, Grade 1 Certified.
- 3-hour UL/ULC Fire rating for "A" label doors.
- Meets A.D.A. accessibility standard.
- Both housings are weather resistant.
- LectorBolt™ - **eliminates running wiring.**
- **3-year warranty from date of installation.**  
**Built-in warranty counter in lock memory.**

The E-Plex 5000 Series combines the strength, simplicity and reliability of Simplex® mechanical push-button locks with the added security and features of electronic access control - it's never been easier to Power Up your access control.

Controls access with up to 100 access codes (upgrades to 300 codes with optional software). Exterior access is by combination or key override, and egress is by interior lever and is free at all times.

**Applications:** Ideal for controlling access to security sensitive areas in commercial, industrial, educational, governmental, healthcare, lodging, and multi-unit residential settings. It's perfect for restricted areas with a high user turnover rate.

**Keyless convenience:** Eliminates problems and costs associated with issuing, controlling, and collecting keys and magnetic cards.

**Flexible operational modes:** Combination (PIN) entry, Passage (programmable), Lockout.

**Easy to manage:** User access programmed at the lock or managed with optional Microsoft Excel™ based software. Users quickly added and deleted. Optional software provides increased control as facility's users and access points increase. Five authority levels allow you to control user's access to various lock functions: Master, Manager, User, Service and Maintenance. Service level has authority to gain access once, or programmed for 1 to 24 hours - for service personnel, meeting rooms, and rental space.

**Extensive audit trail for added security:** Lock records last 3,000 events (upgrades to 9000 events with optional software) for user accountability.

**Flexible user preferences:** Adjustable anti-tamper lockout disables lock after 3 to 9 invalid entry attempts for up to 90 seconds. Adjustable relock time after combination entry from 2 to 20 seconds. Variable length access codes set from 4 to 8 digits.

**Additional Specifications:** (4) four AA Alkaline batteries-located in interior housing; Battery life up to 180,000 cycles; Lock data is retained if batteries fail; audible and visual indicators; low battery visual indicator.

# E-PLEX®

Stock No.	Key Override
<b>SI-E5031-XK-WL-626</b>	Kaba 90
<b>SI-E5031-XS-WL-626</b>	Schlage "C"

### SPECIFICATIONS

<b>DOOR THICK.:</b>	1-3/8" to 2-1/4"
<b>BACKSET:</b>	2-3/4"
<b>THROW:</b>	1/2"
<b>HANDING:</b>	Non-handed, pre-assembled for left hand, easily changed in field
<b>LOCK BODY:</b>	Height 8-7/8" x Width 3-3/8" x Depth 3-13/16"
<b>MINIMUM STILE:</b>	5"
<b>FINISH:</b>	26D Satin Chrome



©ZIPF LOCK COMPANY

# SIMPLEX

## Simplex - Mechanical Pushbutton Locks



Simplex mechanical pushbutton locks offer a convenient way to control access between public and private areas. There are no keys or cards to manage, no computers to program, no batteries to replace, and combinations can be changed in seconds without removing the lock from the door.

**Simple as 1-2-3.** PIN codes are made up of any combination of one to five numbers (pressed individually or simultaneously). The locks allow thousands of possible PIN code combinations. PIN codes are quickly and easily changed without removing the lock from the door. Eliminates normal expense associated with the issue, control, and collection of keys and magnetic cards.

### SIMPLEX 1000 SERIES HEAVY DUTY LOCK

- 3-hour UL/ULC Fire rating for "A" label doors.
- Highly weather resistant.
- Vandal resistant, solid metal pushbutton (5 buttons).
- **3-year warranty.**



#### To Order, Specify:

Stock No: **SI-1021- Entrance**  
 \*Core Type: **B For Best Type Core**  
 Finish: **26D Satin Chrome**  
**-41**

Core not required on 1011 or 1031 function

#### \*SPECIFY CORE TYPE-

- B**-Best, Arrow
- S**-Schlage

Cores not furnished-we stock Arrow cores w/Best Keyways and Schlage full size cores

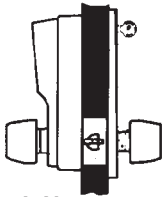
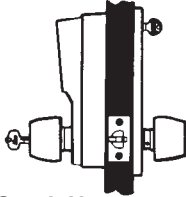
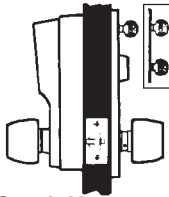
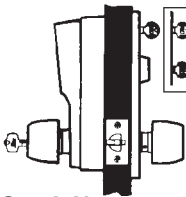

#### STOCK NUMBERS & FUNCTIONS

 <p><b>Stock No.</b> <b>SI-1011</b> Standard model. Access by combination.</p>	 <p><b>Stock No.</b> <b>SI-1021*</b> Access by combination or key bypass.</p>	 <p><b>Stock No.</b> <b>SI-1031</b> Access by combination or passage feature. (Passage feature controlled by thumbturn or key-determined at installation)</p>	 <p><b>Stock No.</b> <b>SI-1041*</b> Access by combination, key bypass or passage feature. (Passage feature controlled by thumbturn or key-determined at installation)</p>
---	--	--	--

**\*SPECIFY CORE TYPE: B**-Best, Arrow or **S**-Schlage. Core not included, order separately.



**Combination Code:** One code per lock made of any combination of one to five numbers (pressed individually or simultaneously). **Number of Combinations:** Thousands of possible combinations. **Emergency Access:** Optional mechanical key override.

#### SPECIFICATIONS

**DOOR THICK.:** 1-5/8" to 2"  
**BACKSET:** 2-3/4"  
**THROW:** 1/2"  
**STRIKE:** ASA and standard strike plates included  
**HANDING:** Factory handed for LH, easily field reversible  
**LOCK BODY:** Height 7-3/8" x Width 3-1/8" x Depth 3-13/16"  
**MINIMUM STILE:** 5" recommended  
**FINISH:** 26D Satin Chrome

#### A NOTE ABOUT THE PASSAGE FUNCTION—

When activated by an inside thumbturn or key cylinder, the outside knob can be set to open the lock without the need for using the pushbutton combination. Designed for use in offices, etc., when the door is to be left unlocked for extended periods.

©ZIPF LOCK COMPANY

# SIMPLEX

## SIMPLEX L1000 SERIES HEAVY DUTY LOCK

- 3-hour UL/ULC Fire rating for "A" label doors.
- Meets A.D.A. accessibility standard.
- Compliance with D.O.D. 5220.22M.
- Highly weather resistant.
- Vandal resistant solid metal pushbutton (5 buttons).
- **3-year warranty.**

# SIMPLEX®

<b>Stock No.</b>	<b>Handing</b>
<b>SI-LL1011-</b>	Left Hand
<b>SI-LR1011-</b>	Right Hand
<b>SI-LL1021*</b>	Left Hand
<b>SI-LR1021*</b>	Right Hand
<b>SI-LL1031-</b>	Left Hand
<b>SI-LR1031-</b>	Right Hand



**\*SPECIFY CORE TYPE-**  
**B**-Best, Arrow  
**C**-Corbin.Russwin  
**S**-Schlage

Cores not furnished-we stock Arrow cores w/Best Keyways and Schlage cores

### FUNCTIONS

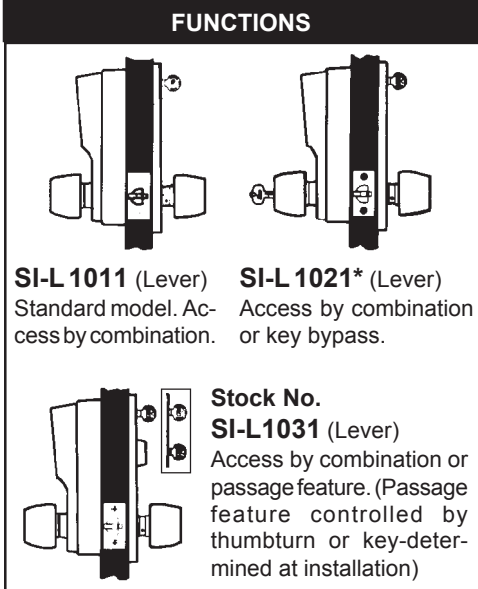

**SI-L 1011 (Lever)** Standard model. Access by combination.

**SI-L 1021\* (Lever)** Access by combination or key bypass.

**Stock No. SI-L1031 (Lever)**  
 Access by combination or passage feature. (Passage feature controlled by thumbturn or key-determined at installation)

**\*SPECIFY CORE TYPE.** Core not included, order separately.

### To Order, Specify:

**Stock No:** **SI-LR1021-** Entrance  
**\*Core Type:** **B** For Best Type Core  
**Finish:** **26D** Satin Chrome  
**-41**

Core not required on 1011 or 1031 function

### SPECIFICATIONS

**DOOR THICK.:** 1-3/8" to 2"  
**BACKSET:** 2-3/4"  
**THROW:** 1/2"  
**STRIKE:** ASA and standard strike included  
**HANDING:** Factory Handed, not field reversible  
**LOCK BODY:** Height 7-3/8" x Width 3-1/8" x Depth 3-13/16"  
**MINIMUM STILE:** 5" recommended  
**FINISHES:** **03** Bright Brass, stocked in 1011 function only.  
**26D** Satin Chrome

## SIMPLEX EE1000 SERIES HEAVY DUTY LOCK

- 3-hour UL/ULC Fire rating for "A" label doors.
- Highly weather resistant.
- Vandal resistant solid metal pushbutton (5 buttons).
- **1-year warranty.**

# SIMPLEX®



**ACCESS CONTROL FROM BOTH SIDES OF THE DOOR**

### SPECIFICATIONS

**DOOR THICK.:** 1-3/4" to 2-1/4"  
**BACKSET:** 2-3/4"  
**THROW:** 1/2"  
**STRIKE:** ASA and standard strike plates included  
**HANDING:** Factory handed for LH, easily field reversible  
**LOCK BODY:** Height 7-3/8" x Width 3-1/8" x Depth 3-13/16"  
**MINIMUM STILE:** 5" recommended  
**FINISH:** **26D** Satin Chrome

**Stock No.**  
**SI-EE1021B/B-26D-41** Combination/Key bypass for entry/egress  
**SI-EE1021S/S-26D-41** Combination/Key bypass for entry/egress  
**B**-for use with Best type cores, **S**-for use with Schlage full size core  
 Cores not included. Order cores separately.

**Combination Code:** One code per lock made of any combination of one to five numbers (pressed individually or simultaneously). **Number of Combinations:** Thousands of possible combinations. **Emergency Access:** Optional mechanical key override.

©ZIPF LOCK COMPANY

# SIMPLEX

## SIMPLEX 5000 SERIES EXTRA HEAVY DUTY LOCK

# SIMPLEX®



- ANSI/BHMA A156.2, Grade 1 Certified.
- 3-hour UL/ULC Fire rating for "A" label doors.
- Meets A.D.A. accessibility standard.
- Highly weather resistant.
- Vandal resistant solid metal pushbuttons (5 buttons).
- **3-year warranty.**

### To Order, Specify:

Stock No. and Core if required.

#### SPECIFICATIONS

<b>DOOR THICK.:</b>	1-5/8" to 2"
<b>BACKSET:</b>	2-3/4"
<b>THROW:</b>	1/2"
<b>STRIKE:</b>	ASA and standard strike included
<b>HANDING:</b>	Factory handed for LH, easily field reversible
<b>LOCK BODY:</b>	Height 8-7/8" x Width 3-3/8" x Depth 3-13/16"
<b>MINIMUM STILE:</b>	5" recommended
<b>FINISHES:</b>	<b>26D</b> Satin Chrome

#### Stock No.

•Key-in-Lever Schlage C Keyway

**SI-5021-XS-WL-26D**

•Best & compatibles (core not included)

**\*SI-5021-B-WL-26D**

\*Please specify if core required.

Ideal for high-traffic security-sensitive area where access control is required. **Combination Code:** One code per lock made of any combination of one to five numbers (pressed individually or simultaneously). **Number of Combinations:** Thousands of possible combinations. **Code Changing:** Accomplished with the lever release combination change tool from the lock exterior (5021). **Emergency Access:** Mechanical key override.

**Application**—Model 2015 and LP1000 (next page) exit device controls are designed to operate surface mount (rim-mounted) exit devices from the outside using a tailpiece, which replaces the key cylinder on new or existing devices. Any standard pull can be mounted with model 2015. They provide exterior access by combination, while allowing free egress at all times by interior exit device. The locks can be used with many leading brands of surface-mounted (rim-mounted) exit devices.

## SIMPLEX 2015 SERIES EXIT DEVICE CONTROL

# SIMPLEX®

- Highly weather resistant.
- Vandal resistant metal pushbuttons (5 buttons).
- 1-year warranty.

#### SPECIFICATIONS

<b>DOOR THICK.:</b>	1-3/8" to 2-1/2"
<b>LOCK BODY:</b>	Height 8-5/8" x Width 3-1/8" x Depth 2-3/4"
<b>TAILPIECE:</b>	2-3/4" adjustable tailpiece for exit device operation from outside
<b>HANDING:</b>	For non-handed or clockwise-rotating exit device hubs only (adjustable up to 90°)
<b>MINIMUM STILE:</b>	3-1/8" recommended
<b>FINISH:</b>	<b>26D</b> Satin Chrome

6-pin tumbler cylinder keys for combination change access. Keyed Different.

Exit device & handle not included. Order separately.

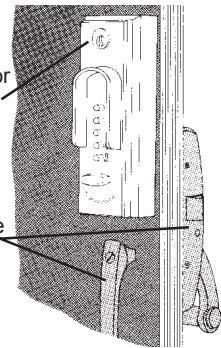

#### Stock No.

**SI-2015-26D-41**

**Finish: Satin Chrome**

#### EXIT DEVICE COMPATIBILITY (subject to change)

- American Device 6300 Series, 6303 Series
- Corbin 21, 22, 25, 26NT, 27K, 29, 29-1/4, 29M2, 29-1/2M2, 29NTM2, 29D20, LA29, 39, 39EL, 39LLD, 390, LA39
- Detex Advantex Series 10, 20, 21, 40, 50, 51
- Magno Krom LHR only: 500-4, 550-4, 650-4, 1500-4, 1550-4, 1650-4; RHR only: 600-3
- Monarch 18RBA, 18RP, 18VP, F18RBA, F18RP, F18VP, FXXRBA, FXXRP, FXXVP, XXRBA, XXRP, XXVP
- Precision Hardware FL-D103; RHRB only 810-H; RH or LH: 103, R103, D203, H-203, 1103, D1203, H1203
- Russwin 365, 365 1/4, LT365, 370, 372, LA372, 375, LT375, 377, 382, 384, 385, 388, 572, 572EL, 572ELD, U572, LA572
- Sargent 2813, 2804, 6804, 12-6804, 9804RHRB, 12-9804LHRB, 9898E, 9898K
- Von Duprin 22 Rim, 22 Rim-F, 88 Rim, 88 Rim-F, 98 Rim, 98 Rim-F, 99 Rim, 99 Rim-F; 2227, 2227-F, 9827, 9827-F, 9847, 9847-F, 9927-F, 9947-F
- Yale 1500 Series, 7000 Series





# SIMPLEX

**Application**—Model 2015 (previous page) and LP1000 exit device controls are designed to operate surface mount (rim-mounted) exit devices from the outside using a tailpiece, which replaces the key cylinder on new or existing devices. Any standard pull can be mounted with model 2015. They provide exterior access by combination, while allowing free egress at all times by interior exit device. The locks can be used with many leading brands of surface-mounted (rim-mounted) exit devices.

## SIMPLEX LP1000 SERIES EXIT DEVICE OPERATOR

- 3-hour UL/ULC Fire rating for "A" label doors.
- Highly weather resistant.
- Vandal resistant solid metal pushbuttons (5 buttons)
- **3-year warranty.**

# SIMPLEX®

**Need a core or exit device??  
Just let us know.**

LP1000 Series can not be used with mortise design and most vertical rod exit devices.

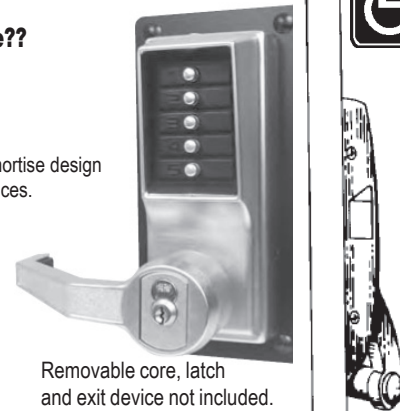

Removable core, latch and exit device not included. Can order separately.



### SPECIFICATIONS

**DOOR THICK.:** 1-3/8" to 2-1/4"  
**LOCK BODY:** Height 8-3/4" x Width 4-3/8" x Depth 3-15-16"  
**TAILPIECE:** 2-3/4" tailpiece for exit device operation from outside  
**HANDING:** Factory handed, not field reversible  
**MINIMUM STILE:** 5"  
**FINISH:** 26D Satin Chrome

### EXIT DEVICE COMPATIBILITY:

- **Von Duprin:** Exit Only (EO) or Exit Only Fire (EOF) 22, 88 NL, 98, 99, 9857, 9957.
- **Detex Advantex Series:** 10, 20, 21, 40, 50, 51.
- **Dorma:** 9100, 9300, 9400.
- **Monarch:** XXR\*, FXXR\*, 18R\*, F18R\*, XXV\*, FXXV\*, 18V\*, F18V\*.  
 (\*Requires special K adapter - contact Monarch)  
 Cannot be used with most vertical rod exit device.

Stock No.	Description
<b>SI-LLP1020B-26D-41</b>	Left Hand, For Best type core
<b>SI-LRP1020B-26D-41</b>	Right Hand, For Best type core
<b>SI-LLP1020S-26D-41</b>	Left Hand, For Schlage full size core
<b>SI-LRP1020S-26D-41</b>	Right Hand, For Schlage full size core

**Application**—Model 3000 series locks provide fully mechanical pushbutton access control for narrow stile aluminum glass doors. It provides exterior access by combination or key override, while allowing free egress at all times.

Model 3000 series is designed for use with Adams Rite 4510/4710/4910 mortise latch mechanisms (order separately). Any standard MS mortise cylinder that operates the Adams Rite latch will function with the 3000 series lock. Suitable for inswing and outswing doors.

## SIMPLEX 3000 SERIES NARROW STILE LOCKS

- Highly weather resistant.
- Vandal resistant solid metal pushbuttons (5 buttons)
- 1-year warranty.

### SPECIFICATIONS

**LOCK BODY:** Height 9-5/8" x Width 1-17/32" x Depth 2-5/8"  
**BACKSET:** 3010 & 3020 31/32"; 3030 & 3040 1-1/8"  
**STILE WIDTH:** 1-7/8" minimum, required for mounting  
**DOOR THICK.:** 1-3/4" maximum

### Features:

**Key override** can be used to override the lock combination and gain access using a key. This feature allows facilities to initiate or maintain a master-keyed security system. The lock accepts MS (maximum security) mortise cylinders.

**Passage (latch holdback)** allows access without using the lock entry code, keeping the door unlocked. This feature is activated from the outside using cylinder override key.

**Lockout** disables the lock so that entry codes cannot be used to gain access. Access is permitted using the key override only. This feature is activated from the outside using the cylinder override key.

You must order housing and drive assembly for complete lock

LATCH NOT INCLUDED  
Order separately.

CYLINDER NOT INCLUDED  
Order separately.



### Housing—

Stock No.	Finish
<b>SI-3001-26D-41</b>	Satin Chrome
<b>SI-3001-55-41</b>	Duranodic

### Drive Assembly—

Stock No.	Backset and Handing
<b>SI-3010-19-41</b>	31/32" backset RH or RHRB
<b>SI-3020-19-41</b>	31/32" backset LH or LHRB
<b>SI-3030-19-41</b>	1-1/8" backset RH or RHRB
<b>SI-3040-19-41</b>	1-1/8" backset LH or LHRB

©ZIPF LOCK COMPANY

# SIMPLEX

1-year warranty

## SIMPLEX 900 SERIES LIGHT COMMERCIAL/ RESIDENTIAL LOCK

# SIMPLEX®

### Spring Latch Function (Night Latch)—

Locks automatically when door closes and requires correct combination to re-open from outside. Can always be opened from inside by turning lever. The thumb slide on inside housing is used to hold the deadlocking latch in a retracted position to keep the Simplex lock open, when desired. For doors that swing out, the latch bolt can be reversed.

### Deadbolt Function—

To open from outside, press combination and turn front knob to open. The lock remains open (bolt retracted) until either the inside lever or outside knob is turned to throw bolt into locked position.

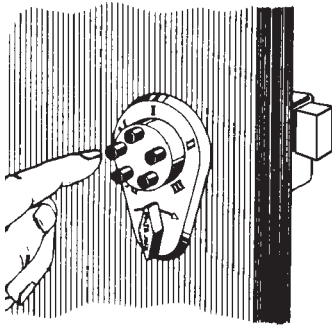

### SPECIFICATIONS

**Backset:** Outswing door: 2-9/16"  
Inswing door: 2-1/2"  
**Latch:** On Deadbolt lock 1"  
**Keypad:** Vandal resistant, 5 button.  
**Handing:** Field reversible latch. Invert lock for right hand door.  
**Bore:** 1-5/8" for barrel, 3/4" for thumbturn, 7/8" for key override  
**Warranty:** 1 year  
**\*Door Thickness:**  
1-3/8" for 1-3/8" to 1-1/2" thick doors  
1-3/4" for 1-3/4" to 2-1/8" thick doors

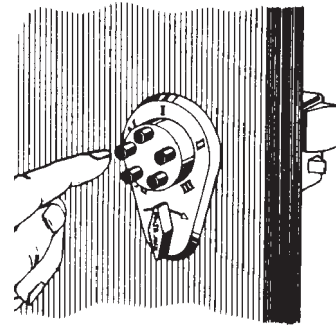

### •Deadbolt door lock with 1" bolt—

Stock No.	Thick*	Finish
SI-9020000-04-41**	1-3/8"	Satin Brass
SI-9020000-26D-41	1-3/8"	Satin Chrome
SI-9040000-04-41	1-3/4"	Satin Brass
SI-9040000-26D-41	1-3/4"	Satin Chrome

### •Above Lock With Key By-pass Cylinder—

Stock No.	Thick*	Finish
SI-9060000-04-41**	1-3/8"	Satin Brass
SI-9060000-26D-41**	1-3/8"	Satin Chrome
SI-9100000-04-41**	1-3/4"	Satin Brass
SI-9100000-26D-41	1-3/4"	Satin Chrome

\*\*Special order



### •Spring Latch door lock with hold back—

Stock No.	Thick*	Finish
SI-9170000-04-41	1-3/8"	Satin Brass
SI-9170000-26D-41	1-3/8"	Satin Chrome
SI-9190000-04-41	1-3/4"	Satin Brass
SI-9190000-26D-41	1-3/4"	Satin Chrome

### Key By-pass Option—

Above models (deadbolt & night latch) are available with an optional key cylinder that provides the flexibility of a master key system and the security advantages of a combination lock. Employees, tenants, etc., use the pushbutton combinations. The key insures entry, regardless of the combination setting used.

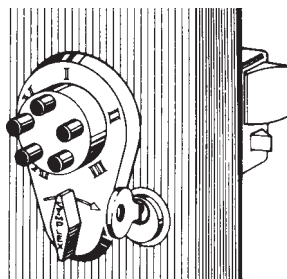

### INSIDE VIEW

of Spring (Night) Latch Function

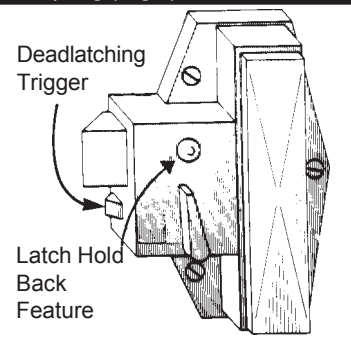

### Adapter Kit For Metal Door & Frame Installations—

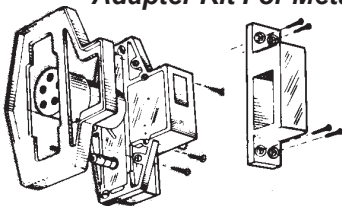

Chrome Finish  
SI-800-26D-41

Adapter kit containing a special surface-mounted cast strike and adjustable riser plate as shown is available. The special strike is fastened to the inside surface of the metal frame and eliminates the need to cut or mortise the frame for the standard strike. The adjustable riser plate raises the lock housing to ensure proper alignment of the latch or dead bolt with the special strike.

### For Wood Door And Frame Installation—

Just drill two holes—one 7/8" and one 1-5/8". All Simplex 900 Series Door Locks require a minimum flat surface of 3-3/4" on inside of door to mount. FOR METAL DOOR INSTALLATION, YOU SHOULD ORDER THE SI-800-26D-41 ADAPTER KIT

©ZIPF LOCK COMPANY

# SIMPLEX

## SIMPLEX 6200 SERIES LIGHT COMMERCIAL/ RESIDENTIAL LOCK

- 3-hour UL.ULC fire rating for "A" label doors.
- Vandal resistant solid metal pushbuttons (5 buttons).
- Retrofits 2-1/8" standard bore cylindrical locksets.
- **1-year warranty.**

### SPECIFICATIONS

**LOCK BODY:** Height 5-7/8" x Width 2-3/4" x Depth 2-9/16"  
**BACKSET:** 2-3/4"  
**THROW:** 1/2"  
**BORE:** 2-1/8" plus 2 additional holes  
**STRIKE:** T-strike with strike box  
**DOOR THICK.:** 1-3/8" to 2-1/4"  
**MINIMUM STILE:** 5"  
**HANDING:** Factory handed left, easily field reversible

# SIMPLEX®

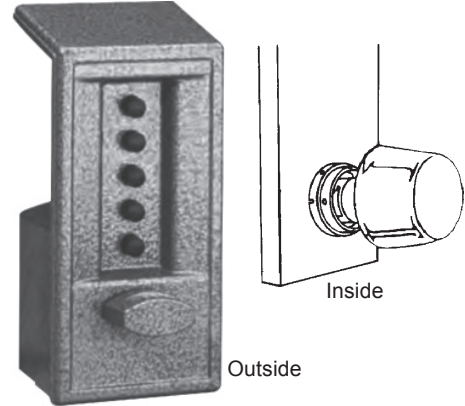

<b>Stock No.</b>	<b>Finish</b>
<b>SI-6204-60-41</b>	Gold Tone
<b>SI-6204-86-41</b>	Grey

Access by combination, while allowing free egress at all times by interior knob. The lockset automatically relocks each time the door closes. The lock can be inverted if the existing auxiliary lock obstructs installation.

**Combination Code:** One code per lock made of any combination of one to five numbers (pressed individually or simultaneously). **Number of Combinations:** Thousands of possible combinations.

## SIMPLEX 7100 SERIES LIGHT COMMERCIAL/ RESIDENTIAL LOCK

- Vandal resistant solid metal pushbuttons (5 buttons).
- Highly weather resistant.
- **1 year warranty.**

### SPECIFICATIONS

**LOCK BODY:** Height 6-1/2" x Width 2-1/2" x Depth 2-1/2"  
**BACKSET:** varies by model number  
**THROW:** varies by model number  
**BORE:** 1-3/8" x 1"  
**STRIKE:** **7102, 7108:** Flat strike  
**7104:** curved lip strike  
**DOOR THICK.:** 1-3/8" to 2-1/4"  
**MINIMUM STILE:** 4"  
**HANDING:** Field reversible

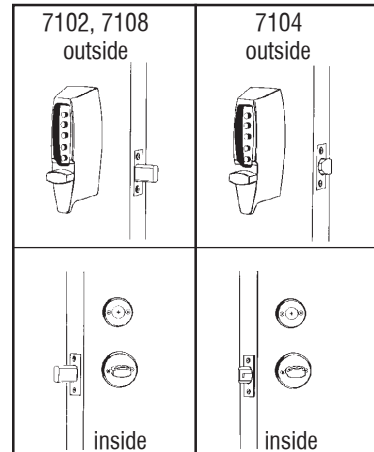

<b>Stock No.</b>	<b>Finish</b>
• 1" deadbolt, 2-3/4" backset, Manual relock.	
<b>SI-7102-03-41</b>	Bright Brass
<b>SI-7102-26D-41</b>	Satin Chrome
• 1" deadbolt, 2-3/8" backset, Manual relock.	
<b>SI-7108-03-41</b>	Bright Brass
• 1/2" deadlocking latch, 2-3/8" - 2-3/4", Auto relock.	
<b>SI-7104-03-41</b>	Bright Brass

The 7100 Series lockset provides fully mechanical primary or auxiliary push-button access control by exterior combination, while allowing free egress at all times by interior thumbturn. Deadbolt models are manually relocking. Deadlocking models automatically relock each time the door closes. 7100 Series locks mount above the existing lockset, or can be used alone.

**Combination Code:** One code per lock made of any combination of one to five numbers (pressed individually or simultaneously). **Number of Combinations:** Thousands of possible combinations.

**REMEMBER: If you don't see what you need,  
please contact us with your requirements.**

# SIMPLEX

## SIMPLEX LD450 SERIES LIGHT DUTY APPLICATION

- Easily installs on wood or metal doors.
- Vandal resistant, metal pushbutton.
- **1-year warranty.**

# SIMPLEX®



Solid cast housing:  
Cast knob (outside)  
and lever (inside).

SPECIFICATIONS	
<b>DOOR THICK.:</b>	1-3/8" to 2-1/2"
<b>BACKSET:</b>	2-3/8" or 2-3/4", depending on lock ordered
<b>THROW:</b>	1/2"
<b>STRIKE:</b>	T-strike, 1-1/8" x 2-3/4"
<b>HANDING:</b>	Non-Handed, pre-assembled for right hand doors, easily changed in the field
<b>LOCK BODY:</b>	Height 6-1/16" x Width 2" x Depth 2-3/16"
<b>MINIMUM STILE:</b>	3-1/2"
<b>FINISH:</b>	<b>03*</b> Bright Brass <b>05*</b> Antique Brass <b>32D</b> Satin Stainless

*\*While supplies last. Discontinued by factory.*

Knob Lock	Backset
<b>SI-LD451-xx-41</b>	2-3/8"
<b>SI-LD452-xx-41</b>	2-3/4"

xx=insert finish

Access Control: Mechanical push-button lock—eliminates problems and cost associated with issuing, controlling, and collecting keys and cards. No Battery: Fully mechanical lock eliminates the material and labor expense of battery replacement. Number of Codes: Single access code—one easy to manage code for all users. Programming: Lock is programmed via keypad once removed from door. Handing: Pre-assembled for right hand doors installations (easily changed in field).

## SIMPLEX LD450 SERIES LIGHT DUTY APPLICATION

- Easily installs on wood or metal doors.
- Vandal resistant, metal pushbutton.
- **1-year warranty.**

SPECIFICATIONS	
<b>DOOR THICK.:</b>	1-3/8" to 2-1/2"
<b>BACKSET:</b>	2-3/8" or 2-3/4", depending on lock ordered
<b>THROW:</b>	1/2"
<b>STRIKE:</b>	T-strike, 1-1/8" x 2-3/4"
<b>HANDING:</b>	Non-Handed, pre-assembled for right hand doors, easily changed in the field
<b>LOCK BODY:</b>	Height 7-7/16" x Width 2-1/4" x Depth 3"
<b>MINIMUM STILE:</b>	3-1/2"
<b>FINISH:</b>	<b>03*</b> Bright Brass <b>05*</b> Antique Brass <b>32D</b> Satin Stainless

*\*While supplies last. Discontinued by factory.*

Solid cast housings; solid cast levers: break away lever to keep would be vandals from damaging drive components.



Lever Lock	Backset
<b>SI-LD471-xx-41</b>	2-3/8"
<b>SI-LD472-xx-41</b>	2-3/4"

xx=insert finish

## SIMPLEX 1000 SERIES LOCK PARTS

# SIMPLEX®

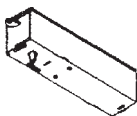

**SI-74366-000-01** (Old #201429-000-01)  
M-56/M-63 combination chamber for 1000, L1000, 3000, 8100 Series.



**SI-204168-26D-01** Satin Chrome  
1/2" floating front throw latch, 2-3/4" backset. For 1000 and L1000 series.



# SIMPLEX

## SIMPLEX 1000 SERIES SERVICE KITS

# SIMPLEX®

If you handle the 1000 Series Pushbutton locks then these Service Kits are a must!! These kits are packaged with all the parts usually required to recondition or refurbish these locks

### 1000 Series Service Kit



**Stock No. SI-203035-000-01**  
**Includes:**  
 Combination Chamber  
 Clutch Assembly  
 Chamber Shaft Bearing  
 Stop Plate  
 Knob Return Spring  
 Key Override Drive Shaft  
 Standard Drive Shaft  
 Key Override Drive Shaft 1-3/8"  
 Standard Drive Shaft 1-3/8"

### L1000 Series Service Kit



**Stock No. SI-203037-000-01** Right Hand  
**SI-203038-000-01** Left Hand

**Includes:**  
 Combination Chamber  
 Clutch Assembly  
 Chamber Shaft Bearing  
 Stop Plate  
 Extension Spring  
 Fixed Sleeve  
 Drive Shaft (key override)  
 Drive Shaft (no key override)  
 Drive Shaft 1-3/8"(key override)  
 Drive Shaft 1-3/8" (no key override)

## SIMPLEX 900 SERIES LOCK PARTS

# SIMPLEX®

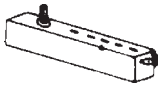

**SI-74080-000-01** (852)  
 M-55 combination chamber for all locks  
 (7/8" x 15/16" x 3-7/8")

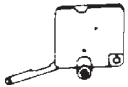

**SI-74167-1-000-01** For Deadlock  
**SI-74163-1-000-01** For Night Latch  
 Gear plate assembly for key bypass models.



**SI-74471-04-01** Brass  
**SI-74471-26D-01** Chrome  
 Inside operating knob assembly, including attaching hardware for all door locks.



**SI-74470-04-01** Brass  
**SI-74470-26D-01** Chrome  
 Outside operating knob assembly, including attaching hardware for all door locks.



**SI-34011-04-01** Brass  
**SI-34011-26D-01** Chrome  
 Latch bolt for night latch (NL) locks.

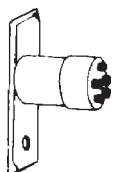

**SI-74124-1-04-01** 1-3/8" locks-Brass  
**SI-74125-1-26D-01** 1-3/4" locks-Chrome  
 Center plate and barrel assembly with five black nylon buttons in a circle.



**SI-54133-04-01** Brass (Limited Supply)  
**SI-54133-26D-01** Chrome (Limited Supply)  
 Special tamper-proof combination change access screw.



**SI-805-26D-41** Chrome  
**Face Plate Shield**—Prevents observation of pushbuttons operations and maintains secrecy of the combination. For use with Models DL and NL. NOT for use with key bypass models.

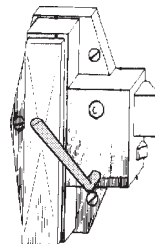

**SI-74437-26D-01** Chrome (Limited Supply)  
**Inside Lever Handle**—This accessory permits unlocking the Simplex latch model and pulling the door open with one hand. Existing locks can be converted by simply removing standard finger operated lever and installing the 2-1/2" lever handle.

©ZIPF LOCK COMPANY

SUPER SPECIAL PRICING AVAILABLE ON ITEMS MARKED WITH ■ - SUPPLIES LIMITED - PLEASE INQUIRE.

223v1  
 (PL-13)