

CYLINDERS

CYLINDERS



Mortise Cylinders

Standard
Straight
Cam

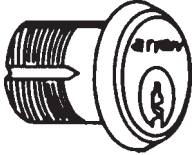

MC61 1-1/8"
US-26D
6 pin

FINISHES: US-3 Polished Brass
US26D Satin Chrome

Rim Cylinders

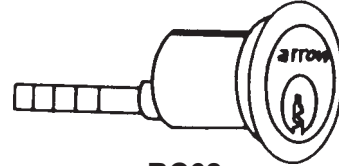

RC62
US-3, 26D
6 pin
Specify Finish

INTERCHANGEABLE CORE CYLINDERS (Less Cores)

FINISHES: US-10 Satin Bronze
US-10B Oil Rubbed Bronze
US26D Satin Chrome

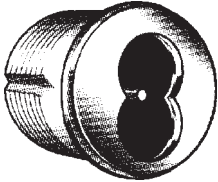

MORTISE CYLINDER
AR-C16CR-16 1-1/8" 6 pin
AR-C16CR-27 1-1/4" 6 or 7 pin
FINISH: US-10, 10B: w/Adams Rite Cam
US-26D: w/001 Standard Cam
1-1/8" only in US-26D

Tapered
Face

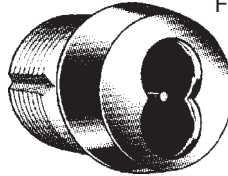

MORTISE CYLINDER
AR-C16CRT-27 1-1/4" 6 or 7 pin
w/Adams Rite Cam
FINISH: 613, US-26D

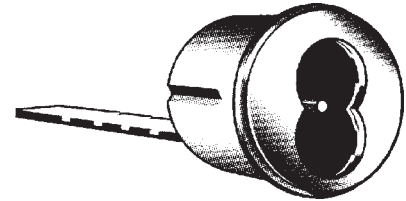

RIM CYLINDER
AR-C16RCR-16 6 pin
AR-C16RCR-27 6 or 7 pin
FINISH: US-26D

See next page for I/C core parts

INTERCHANGEABLE CORE

TAILPIECE ASSEMBLIES

AR-100CR-44-201* 6/7 pin tailpiece assembly for "H" Series IC
AR-550CR-44-201 6/7 pin tailpiece assembly for "MK" Series IC
AR-HSCR-44-201* 6/7 pin tailpiece assembly for "Q" & "ML" Series IC
*Will not fit 15 and 19 functions.

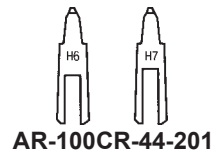

AR-100CR-44-201

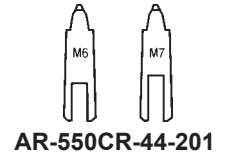

AR-550CR-44-201

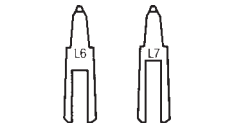

AR-HSCR-44-201

UNCOMBINATED CORES

Stock No.	Description
AR-100CR-UC-	6 pin core
AR-7100CR-UC-	7 pin core

Keyways stocked:
ARROW: 1D
BEST: AB, BB, DB, EB, FB, GB, HB, JB, KB, MB



TO ORDER CORE, SPECIFY: Stock No. + Keyway Code + Finish = AR-7100CR-UC-AB 26D

See next page for I/C core parts

©ZIPF LOCK COMPANY

272 v2
(PL-21)

SUPER SPECIAL PRICING AVAILABLE ON ITEMS MARKED WITH ■ - SUPPLIES LIMITED - PLEASE INQUIRE.

CYLINDERS

REPLACEMENT CYLINDER PACKS IN COMPETITIVE KEYWAYS

Each pack contains:
1 brass cylinder, 2 brass key blanks-(5 pin), and Appropriate tailpiece(s)

CYLINDER PACKS—

Pack No.	Description
PK96C	D60 & E60 Series, except double cyl. 1-3/8" or 1-3/4" door
PK96DC	D60 & E60 Series, double cyl. 1-3/8" or 1-3/4" door
PK100C	H, ML, MK Series, Knob or Lever Lock

KEYWAYS: A(Arrow); CS(C keyway); ES(E keyway)
FINISHES: US-4 or US-26D

TO ORDER:

Specify Pack No. Keyway Finish
PK100C CS US-4

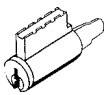

Cylindrical Lock Cylinder



ASSA ABLOY

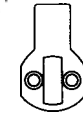

AR-001

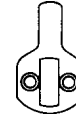

AR-004
N Series,
Exit Devices,
Alarms



AR-18
(Adams Rite)



AR-AM2



AR-006
(Schlage)

MORTISE HOUSING PARTS

Stock No.	Description
AR-3-48 X 3/16	Cam Set Screw
AR-C16CR-122	Washer
AR-C16CR-121A	Adaptor Assembly - 7 pin

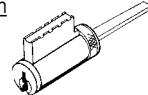

Deadlock Cylinder

TWIN/6000 SERIES CYLINDERS

ASSA

"DELTA/TE KEYWAYS"

FINISHES: **605** Bright Brass
606 Satin Brass
624 Dark Oxidized
625 Bright Chrome
626 Satin Chrome

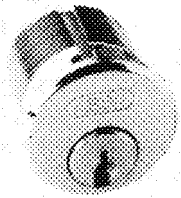

MORTISE CYLINDER

Twin
6000

ITEM	CAM	LENGTH	FINISH
6551-1	Adams Rite, Narrow	1-1/8"	605, 624, 625, 626
6552-5	Standard Yale	1-1/4"	624, 625

• All sub-assembled, no sidebar(SNS)

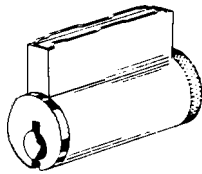

KEY-IN-KNOB CYLINDER

Twin
6000

ITEM	MAKE	FOR USE WITH TYPE:	FINISH
65611	Schlage	Standard & Heavy Duty 6 pin	606, 624, 626
65631	Yale	Standard & Heavy Duty 6 pin	606
65652	Ruswin/Corbin	Standard Duty New Style	626
65672	Sargent	Heavy Duty 7, 8 & 9 Lines	626
65673	Sargent	Standard Duty 6 Line	606, 626
65691	Arrow	Standard & Heavy Duty 6 pin	606, 626

For more information on ASSA, See page 113.
Available in more restricted keyways. Call for details.

Cams & Tailpieces

AS-867445	#1 Adams Rite Cam
AS-867447	#4 Corbin Bever Tail Cam
AS-867452	#2 Sargent Cam
AS-867453	#6 Schlage "L" Cam
AS-867450	Horizontal & Vertical Rim Tailpiece Kit
AS-872610	#5 Yale/Standard Cam

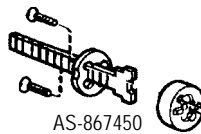

AS-867450



AS-867445



AS-867447



AS-867452



AS-867453



AS-872610

Screws

\$AS-867090	Phillips Screw For Cam
AS-868138	Slotted Screw For Rim Tailpiece
AS-900209	Kit, includes plate and 2 screws

©ZIPF LOCK COMPANY

CYLINDERS

HIGH SECURITY KEY SYSTEMS - With Open Profile "A" Keyway

CAL-ROYAL

The CRP Securities High Security Key (HSK) System utilizes the innovative Sidebar technology to bring you superior and manageable Key Control. Together with distinct keyways and controlled means of key blank distribution, the Sidebar offers a superior level of Key Control Management. Keys can be cut on any standard duplicating and code cutting machines. All cylinders can be master keyed (MK), keyed-alike (KA) and keyed-different (KD).

The HSK System is designed for use in institutions, schools, hospitals, banks and all commercial and residential applications. The Sidebar series keyway is a proprietary design that is distributed in a controlled manner. Cal-Royal offers a cost-effective level of security comparable to other expensive high security control systems.

Maximum pick resistance is assured in HSK Systems with the utilization of anti-picking side pins and random mushroom top pins secured by cap screws. Standard cylinders are equipped with 2 or 3 hardened steel pins in the cylinder plug face for the ultimate in drill resistance. This protects the top and bottom pins and the sidebar from drilling attack. **We stock the open profile "A" keyway cylinders with the sidebar feature.**

Key-in-Knob/Lever Cylinder Features:

- ANSI/BHMA A156.30 Certified.
- Retrofits all CRP-Securities cylindrical locksets and deadbolts including other popular brand names.
- Unique floating side bar pins.
- Patented Cylinder plug and Key.
- Open Profile Keyway.
- Pick-Resistant Spool Pins.
- Hardened Silver Nickel Side Bar.
- 0-Bitted. Two key blanks included.
- Two Anti-Drill Hardened Steel Pins
- Comes standard with different tailpieces (shown above) for universal application and 2 key blanks.



- 1- Key
- 2- Plug
- 3- Anti-Drill Pin
- 4- Bottom Pin
- 5- Side Bar Spring
- 6- Side Bar
- 7- Side Pin
- 8- Cylinder Housing
- 9- Top Pin
- 10- Top Pin Spring

- 11- Cap Set Screw
- 12- Screw Cap Spring
- 13- Screw Cap Pin
- 14- Tailpiece
- 15- Washer
- 16- Screw Cap

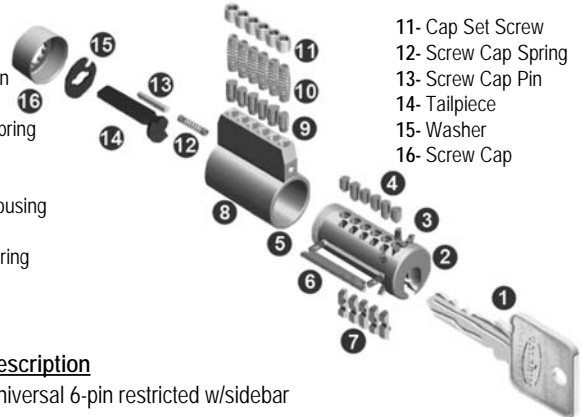

Key-in-Knob/Lever Cylinders

Stock No.	Description
HSK-KIKL6 26D 0B	Universal 6-pin restricted w/sidebar

*Mortise-Rim Combo Cylinder Features:

- ANSI/BHMA A156.30 Certified.
- 1-1/8" cylinder has Mortise and Rim combination kit that saves stocking space and inventory.
- Cylinder rings available for 1" cylinder requirements using MRCC114 or MRC118.
- Unique floating side bar pins.
- Patented Cylinder and Key.
- Pick-Resistant Spool Pins.
- Three Anti-Drill Hardened Steel Pins.
- Hardened Silver Nickel Side Bar.
- Open Profile Keyway.

- See above for Nos. 1 thru 15
- 26- Cam
 - 27- Cam Screw
 - 28- Plate
 - 29- Steel Ball
 - 30- Bolt
 - 31- Screw



Rim kit only available with 1-1/8" cylinder.

*Mortise-Rim Combo Cylinders-

Stock No.	Description
HSK-MRC114 26D 0B	6-pin, 1-1/4" restricted w/sidebar w/o rim kit
HSK-MRC118 26D 0B	6-pin, 1-1/8" restricted w/sidebar w/rim kit*

*Cylinder is shipped as a mortise cylinder but is convertible to a RIM cylinder with the standard RIM pack included on select mortise cylinders. An "Adams Rite" cam is pre-installed on all mortise cylinders.

Any Pinning kit and/or pins used to key Schlage can be used for keying the above cylinders

High Security Key Blank -

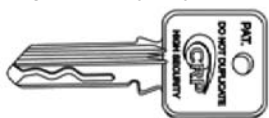

HSK-KBL-6A 6-pin w/sidebar

Mortise Cylinder Cams -



HSK-CAMYALE-2A
Yale Cam (#2A)

HSK-CAMADAM-1
Adams Rite Cam (#1)



CYLINDERS

CYLINDERS

Kwikset

REPLACEMENT CYLINDERS

<u>For:</u>	<u>Stock No.</u>
740 (Hancock) Entry Locksets	KW-13752
740 (Abbey) Entry Locksets	KW-7750A
780 Single Cylinder Deadbolt	KW-87765
785 Double Cylinder Deadbolt (Interior)	KW-87767
785 Double Cylinder Deadbolt (Exterior)	KW-87766

Specify finish: US-3 or 26D (some also LO3, 5, 15A)

KNOB CYLINDER COVERS

<u>For:</u>	<u>Stock No.</u>
Cortez, Roman, Hancock Design	KW-8501-01*
780 Single Cylinder Deadbolt	KW-81327
785 Double Cylinder Deadbolt	KW-81328

Specify finish: US-3 , 5, 26D (*also US-LO3)

KNOB CYLINDERS WITH OPTIONAL KEYWAYS

<u>For:</u>	<u>Stock No.</u>
Weiser Keyway	KW-8497-76

Specify finish: US-3 or 26D

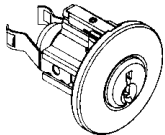

KW-1850 US-3
Replacement cylinder for Kwikset 400 Series Knob Locks. (Not Eclipse or Polo)

LEVERS & LAUREL KNOB CYLINDERS WITH OPTIONAL KEYWAYS (Special order)

<u>For:</u>	<u>Stock No.</u>
Schlage Keyway	KW-81355
Weiser Keyway	KW-81354

Specify finish: US-3 or 26D

DEADBOLT CYLINDERS WITH OPTIONAL KEYWAYS

<u>For:</u>	<u>Stock No.</u>
Schlage Keyway	KW-8486-75
Weiser Keyway	KW-8486-76

Specify finish: US-3 or 26D

REKEYING TOOLS

<u>For:</u>	<u>Stock No.</u>
Schlage Keyway	KW-8485-75
Weiser Keyway	KW-8485-76
Master Keyway	*KW-8485-77
Weslock Keyway	*KW-8485-78

*Being Discontinued

CYLINDERS FOR PRO SERIES PADLOCKS

Master Lock

CYLINDERS FOR REKEYABLE PADLOCKS

- Compatible with Nos. 6121, 6125, 6127, 6230, 6321, 6325, 6327, 6830, 6835, 6840, 6850, 7030, 7035, 7040, 7045 and 7050 padlocks.
- Two keys included with each cylinder. KZ padlocks have 2 key blanks included.
- NOW** sold as each (minimum of 2 cylinders)

4-Pin W1 Cylinders-

296W1 KD	Keyed Different
296W1 KZ	Zero-Bitted

5-Pin W15 Cylinders-

296W15 KD	Keyed Different
296W15 KZ	Zero-Bitted

5-Pin W600A (American Lock Keyway) Cylinders-

296W600A KA	Keyed Alike
--------------------	-------------

NOTE: Master use to sell these cylinder by the box. Now they are sold as each. (Minimum of 2 of a number)

- Compatible with Nos. 21, 24, 25, 27, 101, 220 and 230 padlocks.
- Two keys included with each cylinder. KZ padlocks have 2 key blanks included.
- 4 pin cylinder includes special plug extension.
- NOW** sold as each (minimum of 2 cylinders)

4-Pin W1 Cylinders-

294W1 KD	Keyed Different
294W1 KA	Keyed Alike: 2159
294W1 KZ	Zero-Bitted

5-Pin W15 Cylinders-

295W15 KD	Keyed Different
295W15 KZ	Zero-Bitted

5-Pin W17 Cylinders-

295W17 KZ	Zero-Bitted
------------------	-------------

5-Pin W27 Cylinders-

295W27 KA	Keyed Alike: 10L084
295W27 KZ	Zero-Bitted

5-Pin W81 Cylinders-

295W81 KD	Keyed Different
295W81 KZ	Zero-Bitted
295W81KM MK KD	Keyed Different
295W81KM MK KA	Keyed Alike

©ZIPF LOCK COMPANY

SUPER SPECIAL PRICING AVAILABLE ON ITEMS MARKED WITH ■ - SUPPLIES LIMITED - PLEASE INQUIRE.

275^{v3}
(PL-21)

CYLINDERS



MODULAR CYLINDER PARTS

Note-Pictured smaller than actual size.

CAMS FOR MODULAR MORTISE CYLINDERS

- SC-L583-476** L9060 for cylinder length 1-1/8", 1-3/8" and 1-5/8"
- SC-L583-477** L9060 for cylinder length 1-1/4", 1-1/2" and 1-3/4"
- SC-B520-743** For Adams Rite 4070: cylinder length 1-1/8", 1-3/8" and 1-5/8"
- SC-B520-744** For Adams Rite 4070: cylinder length 1-1/4", 1-1/2" and 1-3/4"
- SC-L583-446** For Adams Rite MS: cylinder length 1-1/8", 1-3/8" and 1-5/8"
- SC-L583-447** For Adams Rite MS: cylinder length 1-1/4", 1-1/2" and 1-3/4"
- SC-L583-474** L Series: cylinder length 1-1/8", 1-3/8" and 1-5/8"
- SC-L583-475** L Series: cylinder length 1-1/4", 1-1/2" and 1-3/4"



Cylinder side of cam



SC-L583-274
SC-L583-275



SC-L583-476
SC-L583-477

CAM SCREWS FOR MODULAR MORTISE CYLINDERS

- SC-B520-690** For 1-1/8" and 1-1/4" cylinder lengths (5-40 x 1/2")
- SC-B520-691** For 1-3/8" and 1-1/2" cylinder lengths (5-40 x 3/4")
- SC-B520-692** For 1-5/8" and 1-3/4" cylinder lengths (5-40 x 1")

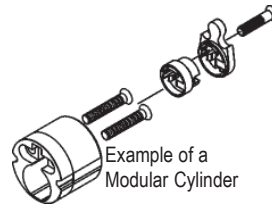

Example of a Modular Cylinder



SC-L583-446
SC-L583-447



SC-B520-743
SC-B520-744

MODULAR CYLINDER HOUSING SCREWS

- SC-B520-693** Modular housing screw (8-32 x 7/8")

PLUG EXTENSIONS FOR MODULAR CAMS

- SC-B590-298** For 1-3/8" and 1-1/2" lengths
- SC-B590-299** For 1-5/8" and 1-3/4" lengths

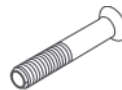

SC-B520-692



SC-B520-691



SC-B520-690

MODULAR CYLINDER TAILPIECES

- SP-A301-337*** A & H Series: For Classic, Everest & Primus (not A73,A85 or ORB)
- SP-A301-338** A & H Orbit: For Classic, Everest & Primus
- SP-N523-022** ND Series: For Classic, Everest & Primus
- SC-B502-899** Rim cylinder tailpiece

*requires C603-098 disc.



SC-B520-299



SC-B520-298



SC-B520-693

CYLINDERS

STANDARD CYLINDERS



See pages 279-284 for Primus and Everest-Primus Cylinders

NOTE: Schlage is doing a rolling change on the cylinders below to a "Modular Cylinder". See previous page for modular cylinder parts.

Reduce Cylinder Inventory—

Multiple tailpiece cylinders allow high inventory flexibility with low investment. Included with each cylinder are tailpieces to suit these locks:

A Series (all designs)

AL Series

D Series Knobs

D Series Levers

ND Series Levers

H Series (all designs)

All cylinders are furnished 0-bitted and are furnished with 2 key blanks

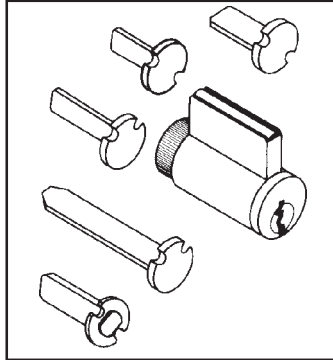

MULTIPLE TAILPIECE KNOB CYLINDERS

Stock No.	Description
40-100-C	Classic C Keyway
40-100-C123	Everest C123 Keyway
40-100-C145	Everest C145 Keyway
40-100-E	Classic E Keyway
40-100-F	Classic F Keyway

FINISHES: **606** Satin Brass
626 Satin Chrome

TO ORDER: Specify Stock No. and Finish.

SCHLAGE KNOB CYLINDERS FOR USE IN OTHER MANUFACTURERS' LOCKS

For Corbin/Ruswin Locks
CK4200 and UT5200 Series
CL3400 and CL3600 Series

Stock No.
24-127-x
24-139-x

For Yale Locks
5300, 5400, 6200 Series Knobs
5300LN, 5400LN Levers

Stock No.
24-123-x
24-147-x

For Sargent Locks
7L, 8L, 10 Line Levers
7, 8, 9 Line Knobs
6 Line-except B Knob

Stock No.
24-119-x
24-120-x
24-126-x

x = Keyway: C or E.
FINISHES: **606** Satin Brass
626 Satin Chrome
TO ORDER: Specify Stock No., Keyway and Finish.

NOTE: Schlage is doing a rolling change on the cylinders below to a "Modular Cylinder". See previous page for modular cylinder parts.

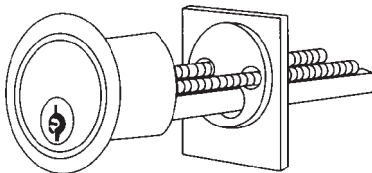

RIM CYLINDERS

Stock No.	Finish
20-022-C	605, 612, 613, 626
20-022-C123	605, 613, 626
20-022-C145	605, 613, 626
20-022-E	605, 613, 626
20-022-F	605, 626

FINISHES: **605** Bright Brass
612 Satin Bronze
613 Oil Rubbed Bronze
626 Satin Chrome

TO ORDER: Specify Stock No. and Finish.

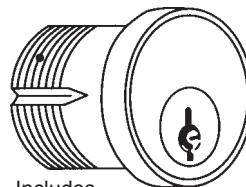

Includes
Compression
Ring and Spring

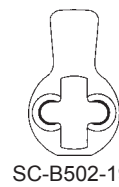

SC-B502-191



SC-L583-254

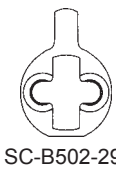

SC-B502-292

MORTISE CYLINDERS

Stock No.	Length	Finish	Standard Cam
20-001-x	1-1/8"	605, 612, 613, 626	SC-B502-191
20-001-x	1-1/4"	605, 626	SC-B502-191
20-013-x	1-1/8"	613, 626	SC-B502-292
30-001-x	1-1/8"	626	SC-L583-254
30-001-x	1-1/4"	626	SC-L583-254

20-013 includes B220-050 set screw pack for Adams Rite.

x = Keyway: C, C123, C145, E, or F. 30-001 only C123 & C145.

FINISHES: **605** Bright Brass **613** Oil Rubbed Bronze
612 Satin Bronze **626** Satin Chrome

TO ORDER: Specify Stock No., Keyway, Finish and Length.

Rim & Mortise cylinders with the C123 & C145 keyway are 0-bitted

©ZIPF LOCK COMPANY

SUPER SPECIAL PRICING AVAILABLE ON ITEMS MARKED WITH ■ - SUPPLIES LIMITED - PLEASE INQUIRE.

277_{v1}
(PL-21)

CYLINDERS

STANDARD CYLINDERS

B560 Single Cylinder - 6 PIN (1-3/8" to 1-3/4")
Order 40-100- cylinder, see next page, and tailpiece SC-B520-651.

B660 SERIES - 6 PIN (Limited availability)
For B660 (Fits 1-3/8" to 2-1/2" doors) **Finish**
22-644-C123 606, 626
22-644-C145 606, 626
For B662 (Fits 1-3/8" to 2" doors) **Finish**
22-645-C123 606, 626
22-645-C145 606, 626

For C, E, F keyways order 40-100- cylinder (see next page) and appropriate tailpiece (page 206)

For deadbolt cylinders not shown please call for details.



SMALL FORMAT (BEST® STYLE) INTERCHANGEABLE CORE HOUSINGS (SFIC)

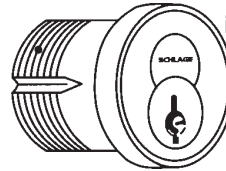

1-3/8" Length
80-102 Straight Cam
80-103 A/R MS Cam

Core not included.



Cam on
80-103
(K510-711)



Cam on
80-102
(K510-730)

Stock No.	Description
80-102-626	Mortise Cylinder Housing-Less Core.
80-103-626	Mortise Cylinder Housing-Less Core.
80-129-626	Rim Cylinder -Less Core (limited supply)

Need Best® Style cores?? Just let us know.

Need your I/C cores keyed?? Just let us know when ordering.

FULL SIZE INTERCHANGEABLE CORE CYLINDERS

Includes Core.

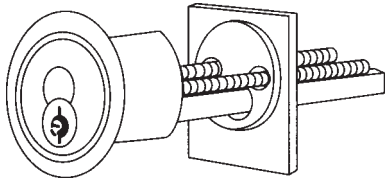

Includes:
Compression Ring,
Spring and 3/8"
Blocking Ring.

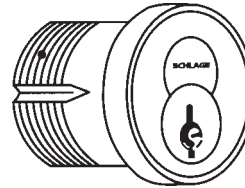

RIM CYLINDERS

With Core—

Stock No. Finish
***20-057-x** 606, 613, 626

*Made up from 20-079 & 23-030.
x = Keyway-see cores below right.

Less core—

Stock No. Finish
20-079 606, 613, 626

FINISHES: **606** Satin Brass
613 Oil Rubbed Bronze (Housing only)
626 Satin Chrome

TO ORDER: Specify Stock No. and Finish.

MORTISE CYLINDERS

Stock No.	Length	Finish	Core	Standard Cam
26-094	1-1/2"	613, 626	Less Core	SC-K510-730
*20-061-x	1-1/2"	613, 626	With Core	SC-K510-730

*Made up from 26-094 & 23-030, x = Keyway-see below.

FINISHES: **606** Satin Brass
613 Oil Rubbed Bronze (Housing only)
626 Satin Chrome

TO ORDER: Specify Stock No., Keyway, Finish and Length.

INTERCHANGEABLE CORES

Stock No.	Finish
23-030-C	606, 626
23-030-C123	626
23-030-C145	626
23-030-E	606, 626

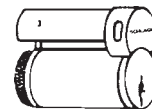

FINISHES: **606** Satin Brass
626 Satin Chrome

TO ORDER: Specify Stock No. and Finish.

SEE PAGE 201 FOR INTERCHANGEABLE CORE CONTROL KEY BLANKS

ALL Interchangeable cores are stocked 1-bitted.

©ZIPF LOCK COMPANY

278 v2 SUPER SPECIAL PRICING AVAILABLE ON ITEMS MARKED WITH ■ - SUPPLIES LIMITED - PLEASE INQUIRE.
(PL-21)

CYLINDERS

Primus Security Cylinders

What is PRIMUS®??

Primus is a patented sidebar cylinder and key designed for key control, pick resistance and attack resistance. Primus is Schlage's highest security cylinder and is available in two families of keyways, Classic and Everest®. Classic Primus cylinders can be incorporated into most existing Classic key systems. Everest Primus can be incorporated into any Everest key system. Primus systems are more economical than most other high security cylinders because you don't have to install Primus cylinders on every door. You can have *conventional cylinders* in most locks, *Classic Primus Controlled Access* cylinders in the areas where positive key control and pick resistance are required and *Classic Primus UL Listed High Security* Cylinders where you need resistance to drilling and other physical attacks. Primus cylinders are available to retrofit most popular commercial locks by Corbin-Russwin, Sargent and Yale. This means that you don't have to buy new hardware to convert to Schlage's Primus key systems.

Classic Primus Level 1—Designed for small to medium size businesses.

Overview: Easy introduction to Classic Primus sales; Same side milling nationwide; No minimum initial order required; No sole source relationship with your distributor or customers. You are required to sign a Level 1 contract with each distributor from whom you purchase Level 1 products. In the contract you agree, among other things: To safeguard Classic Primus key blanks; Not to give, sell or lend *key blanks* to anyone under any circumstances; To sell directly to end users only; To issue a Level 1 ID card to each end user; To require ID card and signature before duplicating any Level 1 keys; To maintain accurate records of all keys.

Classic Primus Level 1+—Designed for small to medium size businesses.

Overview: Ties your end users to you for their Classic Primus Level 1+ keys; You are tied to your wholesaler for key blanks; Key blanks are stamped with your ID number; Wholesaler has its own side biting and selects which of its locksmiths will handle the product; Other locksmiths in your area may have the same side biting but are not authorized to cut keys with your ID number; Key blanks are drop shipped to you from Schlage and invoiced through your wholesaler; Level 1+ cylinders are shipped 0-bitted and all keying is done by the locksmith. You are required to sign a Level 1 Plus contract with your wholesaler and purchase the prevailing minimum dollar amount of inventory. In the contract you agree, among other things: Not to cut keys for any Classic Primus 1+ systems other than your own, as identified by the ID number on each key; To safeguard Classic Primus key blanks and ID cards; not to give, sell or lend *key blanks* to anyone under any circumstances; To sell directly to end users only; To require and validate a signature before duplicating any Level 1+ keys; To maintain accurate records of all keys cut.

Classic Primus Level 3 or 4—Higher restriction. For larger applications. Please give us a call.

Everest Primus Level 7—Designed for small to medium size businesses.

Overview: Ties all your end users to you for their Primus Level 7 keys; You are tied to your wholesaler for key blanks; Key blanks have your wholesaler's side biting and are stamped with *your* ID number by Schlage; Wholesaler has its own side biting and selects which of its locksmiths will handle the product; Other locksmiths in your area may have the same side biting; Key blanks are drop shipped to you from Schlage and invoiced through your wholesaler; Level 7 cylinders are shipped 0-bitted and all keying is done by the locksmith. You are required to sign a Level 7 contract with your wholesaler and purchase the prevailing minimum dollar amount of inventory. In the contract you agree, among other things: Not to cut keys for any Primus 7 systems other than your own, as identified by the ID number on each key; To safeguard Primus key blanks and ID cards; not to give, sell or lend *key blanks* to anyone under any circumstances; To sell directly to end users only; To require and validate a signature before duplicating any Level 7 keys; To maintain accurate records of all keys cut.

Everest Primus Level 9—Higher restriction. For larger applications. Please give us a call.

CLASSIC PRIMUS		Typical Applications	EVEREST PRIMUS	
LEVEL	Patent Protected through 2007		Patent Protected through 2014	LEVEL
1	Commercially Exclusive Stocked by distributors and resold to end users via commercial locksmiths: All level 1 locksmiths have the same side bittings.	<ul style="list-style-type: none"> ▪ Strip Mall Shops ▪ Small Businesses ▪ Upscale Homes <hr/> <ul style="list-style-type: none"> ▪ Small Businesses ▪ Restaurants ▪ Doctor's Offices <hr/> <ul style="list-style-type: none"> ▪ Educational Facilities ▪ Healthcare Facilities ▪ Large Office Complexes ▪ Government Buildings ▪ Detention Centers ▪ Franchises 	Considered Everest Open for Commercial Exclusivity	
1+	Wholesaler/Locksmith Exclusive Locksmiths resell wholesaler's side biting to end users; keys bear locksmith ID number.		Wholesaler/Locksmith Exclusive Locksmiths resell wholesaler's side biting to end users; keys bear locksmith ID number.	7
2	Contract Hardware Dealer Exclusive We do not participate in this level.		Servicing Dealer Exclusive We do not participate in this level.	8
3	End User Exclusive Exclusivity is based on either random assignment or on the first 2 digits of the zip code, depending on end user commitment.		End User Exclusive Exclusivity is based on either random assignment or on the first 2 digits of the zip code, on time zone, or on a nationwide basis, depending on end user commitment.	9
4	End User Exclusive Exclusivity is based on either a time zone or nationwide basis, depending on end user commitment.			

©ZIPF LOCK COMPANY

The above information was obtained from Schlage Lock Company's "High Security Cylinders & Key Control Service Manual"

CYLINDERS

LEVEL 1 - CLASSIC

Primus Security Cylinders



"Controlled Access" 20-700 Series. (20-500 High Security UL Listed—Factory order only)

A-AL-D-ND-H Series - 6 Pin Multiple Tailpiece Cylinder(5 tailpieces)	C Keyway-1001 SP-40-700-CP	Finish 606,626	E Keyway-1006 SP-40-700-EP	Finish 606, 626
B100, B250 & B660 Series - 6 Pin <i>Trim rings and driver bars not included</i> For B100, B250 Series For B562 (Fits 1-3/8" to 1-7/8" doors) For B660 (Fits 1-3/8" to 2-1/2" doors) For B662 (Fits 1-3/8" to 2" doors)	C Keyway-1001 SP-20-729-CP SP-20-745-CP SP-20-744-CP SP-20-745-CP	Finish 606, 626 606 606, 626 606	E Keyway-1006 SP-20-729-EP SP-20-745-EP SP-20-744-EP SP-20-745-EP	Finish 606 606 606, 626 606
Mortise Cylinders - 6 Pin A/R Cam, with 3/8" blocking ring and B220-050 set screw pack 1-1/8" length Straight Cam, full face w/compression ring 1-1/8" length 1-1/4" length	C Keyway-1001 SP-20-706-CP-118 SP-20-700-CP-118 SP-20-700-CP-114	Finish 613, 626 605, 612, 613, 626 605, 612, 613, 626	E Keyway-1006 SP-20-706-EP 118 SP-20-700-EP-118 SP-20-700-EP-114	Finish 613 605, 613, 626 605, 612, 613
Rim Cylinder With Horizontal Bar (changeable)	C Keyway-1001 SP-20-710-CP	Finish 605, 612, 613, 626	E Keyway-1006 SP-20-710-EP	Finish 612, 613, 626
Key Blanks Primus Key Blank(side mill only) I/C Control Key Blank(side mill only)	C Keyway-1001 SP-35-157-CP SP-35-158-CP	Minimum of 10 blanks.	E Keyway-1006 SP-35-157-EP SP-35-158-EP	Minimum of 10 blanks.
I. D. Cards Level One	C Keyway-1001 SP-40-061-CP	Minimum of 5 cards.	E Keyway-1006 SP-40-061-EP	Minimum of 5 cards.

Cams pictured smaller than actual size.



Cam used on
20-700 cylinder
20-715 cylinder
SP-B502-948



Cam used on
20-706 cylinder
SP-B502-944

Need a cylinder not listed?? Just give us a call.

To Order, Specify: Catalog Number Keyway Number Finish

Ex: SP-40-700-CP 1001 606 = SP-40-700-CP 1001 606

1001 keyway tells us that you want Primus Level 1 "C" keyway.

CYLINDERS

LEVEL 1 PLUS - CLASSIC

Primus Security Cylinders



"Controlled Access" 20-700 Series. (20-500 High Security UL Listed—Factory order only)

A-AL-D-ND-H Series - 6 Pin Multiple Tailpiece Cylinder(5 tailpieces)	C Keyway-1313 SP-40-700-CP	Finish 606, 626	E Keyway-1318 SP-40-700-EP	Finish 606, 626
B100, B250 & B660 Series - 6 Pin <i>Trim rings and driver bars not included</i> For B100, B250 Series For B562 (Fits 1-3/8" to 1-7/8") For B660 (Fits 1-3/8" to 2-1/2" doors) For B662 (Fits 1-3/8" to 2" doors)	C Keyway-1313 SP-20-729-CP SP-20-729-CP SP-20-744-CP SP-20-745-CP	Finish 606, 626 606, 626 Call 606, 626	E Keyway-1318 SP-20-729-EP SP-20-729-EP SP-20-744-EP -----	Finish 606, 626 606, 626 606, 626
L Series Lockout-Outside Cylinder 1-1/8" length, no ring, for L9060	C Keyway-1313 SP-20-715-CP	Finish 626	E Keyway-1318 -----	Finish
Mortise Cylinders - 6 Pin A/R Cam, with 3/8" blocking ring and B220-050 set screw pack 1-1/8" length Standard Cam, full face w/compression ring 1-1/8" length 1-1/4" length	C Keyway-1313 SP-20-706-CP-118 SP-20-700-CP-118 SP-20-700-CP-114	Finish 613, 626 605, 613, 626 605, 612, 613, 626	E Keyway-1318 SP-20-706-EP-118 SP-20-700-EP-118 SP-20-700-EP-114	Finish 613 605, 612, 613, 626 605, 612
Rim Cylinder With Horizontal Bar (changeable)	C Keyway-1313 SP-20-710-CP	Finish 605, 613, 626	E Keyway-1318 SP-20-710-EP	Finish 605, 612, 613, 626
For Corbin/Ruswin Locks CK4200 and UT5200 Series CL3400 and CL3600 Series	C Keyway-1313 SP-20-727-CP SP-20-739-CP	Finish 626 626	E Keyway-1318* SP-20-727-EP SP-20-739-EP	Finish 626 626
For Sargent Locks 7L, 8L, 10 Line Levers 7, 8, 9 Line Knobs 6 Line (except B knob)	C Keyway-1313 SP-20-719-CP SP-20-720-CP SP-20-726-CP	Finish 626 626 626	E Keyway-1318* SP-20-719-EP SP-20-720-EP SP-20-726-EP	Finish 626 626 626
For Yale Locks 5300, 5400, 6200 Series Knobs 5300LN, 5400LN Levers <i>*E Keyway special order only.</i>	C Keyway-1313 SP-20-723-CP SP-20-747-CP	Finish 626 626	E Keyway-1318* SP-20-723-EP SP-20-747-EP	Finish 626 626
Key Blanks* Primus Key Blanks (side mill only)	C Keyway-1313 SP-35-157-CP	Minimum of 50 blanks.	E Keyway-1318 SP-35-157-EP	Minimum of 50 blanks.
I. D. Cards* Level One Plus	C Keyway-1313 SP-40-065-CP	Order in Multiples of 50.	E Keyway-1318 SP-40-065-EP	Order in Multiples of 50.

**Key blanks and ID cards are special ordered from the factory and shipped to our customer.*

Cams pictured smaller than actual size.



Cam used on
20-700 cylinder
20-715 cylinder
SP-B502-948



Cam used on
20-706 cylinder
SP-B502-944

See next page for Primus Level 1 Plus
Interchangeable Core

To Order, Specify: Catalog Number Keyway Number Finish

Ex: SP-40-700-CP 1313 606 = SP-40-700-CP 1313 606

1313 keyway tells us that you want Primus Level 1 PLUS "C" keyway.

©ZIPF LOCK COMPANY

SUPER SPECIAL PRICING AVAILABLE ON ITEMS MARKED WITH ■ - SUPPLIES LIMITED - PLEASE INQUIRE.

281_{v1}
(PL-21)

CYLINDERS

Primus Security Cylinders



LEVEL 1 PLUS INTERCHANGEABLE CORE

"Controlled Access" 20-700 Series. (20-500 High Security UL Listed—Factory order only)

All Series 6 Pin Core only	C Keyway-1313 SP-20-740-CP	Finish 606, 626	E Keyway-1318 SP-20-740-EP	Finish 606, 626
Mortise Cylinder w/core Standard Cam, compression ring & spring 6 Pin unit, 1-1/2" length	C Keyway-1313 SP-20-763-CP	Finish 605, 626	E Keyway-1318 SP-20-763-EP	Finish 605, 626
Rim Cylinder - Standard Rim w/core With cylinder collar	C Keyway-1313 SP-20-757-CP	Finish 605	E Keyway-1318 SP-20-757-EP	Finish 605, 626
Padlock - (2" wide body) w/core Shackle: 3/8" Dia.; 2" Vert.; 3/4" Hor.	C Keyway-1313 -----	Finish	E Keyway-1318 PL4742EP+	Finish 452 Satin Brass
Key Blanks* Primus Key Blanks (side mill only) Primus Control Key (standard bow) Primus Control Key (embossed 1 side)	C Keyway-1313 SP-35-157-CP SP-35-158-CP SP-35-052-CP	Minimum of 50 blanks. Minimum of 50 blanks. Minimum of 50 blanks.	E Keyway-1318 SP-35-157-EP SP-35-158-EP SP-35-052-EP	Minimum of 50 blanks. Minimum of 50 blanks. Minimum of 50 blanks.
I. D. Cards* Level One Plus	C Keyway-1313 SP-40-065-CP	Order in Multiples of 50.	E Keyway-1318 SP-40-065-EP	Order in Multiples of 50.

*Key blanks and ID cards are special ordered from the factory and shipped direct to our customers..

NOTE: Primus interchangeable cores require the use of a "universal" driver that will accept either standard or Primus cores. Existing locks may require changing the driver to accept Primus cores.

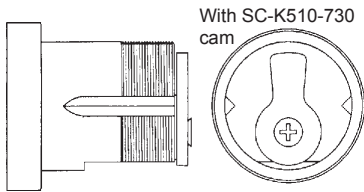

SP-20-763-XX (xx = keyway)
Mortise Cylinder: 1-1/2" long.
No blocking ring.

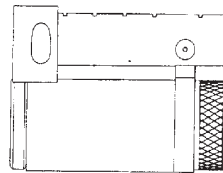

SP-20-740-XX (xx = keyway)
Core only.

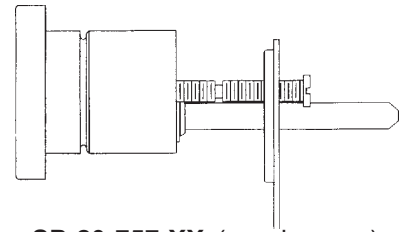

SP-20-757-XX (xx = keyway)
Rim Cylinder.

To Order, Specify: Catalog Number Keyway Number Finish

Ex: SP-20-740-CP 1313 626 = SP-20-740-CP 1313 626

1313 keyway tells us that you want Primus Level 1 PLUS "C" keyway.

CYLINDERS

LEVEL 7 - EVEREST PRIMUS

EVEREST



"Controlled Access" 20-700 Series. (20-500 High Security UL Listed—Factory order only)

<u>A-AL-D-ND-H Series - 6 Pin</u>	<u>C123 Keyway</u>	<u>Finish</u>	<u>C145 Keyway</u>	<u>Finish</u>
Multiple Tailpiece Cylinder(5 tailpieces)	SP-40-700-C123	606, 626	SP-40-700-C145	606
<u>BC100 & B660 Series - 6 Pin</u> <i>Trim rings and driver bars not included</i>	<u>C123 Keyway</u>	<u>Finish</u>	<u>C145 Keyway</u>	<u>Finish</u>
For BC100 Series	SP-20-729-C123	606, 626	SP-20-729-C145	606, 626
For B660 (Fits 1-3/8" to 2-1/2" doors)	SP-20-744-C123	606, 626	SP-20-744-C145	606, 626
For B662 (Fits 1-3/8" to 2" doors)	SP-20-745-C123	606, 626	SP-20-745-C145	606
<u>L Series Lockout-Outside Cylinder</u> w/compression ring & spring 1-1/8" length, for L9060	<u>C123 Keyway</u>	<u>Finish</u>	<u>C145 Keyway</u>	<u>Finish</u>
	SP-20-715-C123	626	SP-20-715-C145	626
<u>Mortise Cylinders - 6 Pin</u> A/R Cam, with 3/8" blocking ring and B220-050 set screw pack 1-1/8" length	<u>C123 Keyway</u>	<u>Finish</u>	<u>C145 Keyway</u>	<u>Finish</u>
	SP-20-706-118-C123	613, 626	SP-20-706-118-C145	613, 626
Standard Cam, full face w/compression ring 1-1/8" length	SP-20-700-118-C123	605, 612, 613, 626	SP-20-700-118-C145	612, 613, 626
1-1/4" length	SP-20-700-114-C123	605, 612, 613, 626	SP-20-700-114-C145	605, 612, 613, 626
<u>Rim Cylinder</u> With Horizontal Bar (changeable)	<u>C123 Keyway</u>	<u>Finish</u>	<u>C145 Keyway</u>	<u>Finish</u>
	SP-20-710-C123	605, 612, 613, 626	SP-20-710-C145	605, 612, 613, 626
<u>For Corbin/Ruswin Locks</u> CK4200 and UT5200 Series CL3400 and CL3600 Series	<u>C123 Keyway</u>	<u>Finish</u>	<u>C145 Keyway</u>	<u>Finish</u>
	SP-20-727-C123	626	SP-20-727-C145	626
	SP-20-739-C123	626	SP-20-739-C145	626
<u>For Sargent Locks</u> 7L, 8L, 10 Line Levers 7, 8, 9 Line Knobs 6 Line (except B knob)	<u>C123 Keyway</u>	<u>Finish</u>	<u>C145 Keyway</u>	<u>Finish</u>
	SP-20-719-C123	626	SP-20-719-C145	626
	SP-20-720-C123	626	SP-20-720-C145	626
	SP-20-726-C123	626	SP-20-726-C145	626
<u>For Yale Locks</u> 5300, 5400, 6200 Series Knobs 5300LN, 5400LN Levers	<u>C123 Keyway</u>	<u>Finish</u>	<u>C145 Keyway</u>	<u>Finish</u>
	SP-20-723-C123	626	SP-20-723-C145	626
	SP-20-747-C123	626	SP-20-747-C145	626
<u>Key Blanks*</u> Primus Key Blanks (side mill only) blanks.	<u>C123 Keyway</u>		<u>C145 Keyway</u>	
	SP-35-004-C123		SP-35-004-C145	Minimum of 50
<u>I. D. Cards*</u> Level Seven	<u>C123 Keyway</u>		<u>C145 Keyway</u>	
	SP-40-060-C123		SP-40-060-C145	Order in Multiples of 50.

*Key blanks and ID cards are special ordered from the factory and shipped direct to our customers.

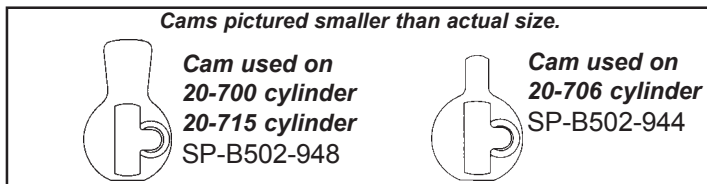

See next page for Everest Primus Level 7 Interchangeable Core and Padlocks.

To Order, Specify: Catalog Number Keyway Number Finish

Ex: SP-20-724- C123 606 = SP-20-724-C123 606

CYLINDERS

LEVEL 7 - EVEREST PRIMUS FULL SIZE INTERCHANGABLE CORE

EVEREST



"Controlled Access" 20-700 Series. (20-500 High Security UL Listed—Factory order only)

All Series	C123 Keyway	Finish	C145 Keyway	Finish
6 Pin Core only	SP-20-740-C123	606, 626	SP-20-740-C145	606
Mortise Cylinder w/core Standard Cam, compression ring & spring 6 Pin unit, 1-1/2" length	C123 Keyway SP-20-763-C123	Finish 605, 613, 626	C145 Keyway SP-20-763-C145	Finish 605, 613, 626
Rim Cylinder - Standard Rim w/core With cylinder collar	C123 Keyway SP-20-757-C123	Finish 605, 613	C145 Keyway SP-20-757-C145	Finish 605, 613, 626
Padlock - (2" wide body) w/core Shackle: 3/8" Dia.; 2" Vert.; 3/4" Hor.	C123 Keyway \$PL4742-C123	Finish 452 Satin Brass	C145 Keyway \$PL4742-C145	Finish 452 Satin Brass
Key Blanks* Primus Key Blanks (side mill only) Primus Control Key (embossed 1 side)	C123 Keyway SP-35-004-C123 SP-35-005-C123	Finish Minimum of 50 blanks. Minimum of 50 blanks.	C145 Keyway SP-35-004-C145 SP-35-005-C145	Finish Minimum of 50 blanks. Minimum of 50 blanks.
I. D. Cards* Level 7	C123 Keyway SP-40-060-C123	Finish Order in Multiples of 50.	C145 Keyway SP-40-060-C145	Finish Order in Multiples of 50.

*Key blanks and ID cards are special ordered from the factory and shipped direct to our customers.

\$=Padlocks are discontinued. Call for closeout prices.

NOTE: Primus interchangeable cores require the use of a "universal" driver that will accept either standard or Primus cores. Existing locks may require changing the driver to accept Primus cores.

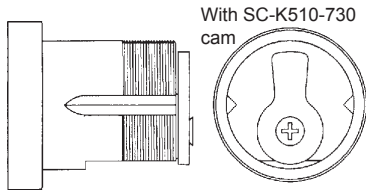

SP-20-763-Cxxx (xxx = keyway)
Mortise Cylinder: 1-1/2" long.
No blocking ring.

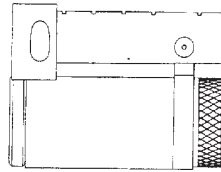

SP-20-740-Cxxx (xxx = keyway)
Core only.

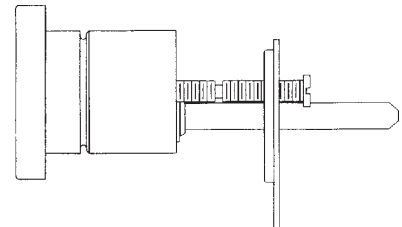

SP-20-757-Cxxx (xxx = keyway)
Rim Cylinder.

To Order, Specify: Catalog Number Keyway Number Finish

Ex: SP-20-740- C123 626 = SP-20-740-C123 626

EVEREST B - SMALL FORMAT (BEST® STYLE) INTERCHANGABLE CORE CYLINDERS (SFIC)

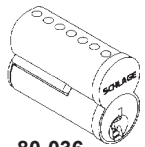

80-036-

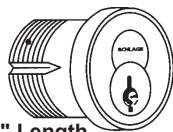

1-3/8" Length
80-102 Straight Cam
80-103 A/R MS Cam



Cam on
80-103
(K510-711)



Cam on
80-102
(K510-730)

Stock No.
80-036-B235-626
80-102-626
80-103-626
80-129-626
35-401

Description

Core Only-**RESTRICTED***
Mortise Cylinder Housing-Less Core.
Mortise Cylinder Housing-Less Core.
Rim Cylinder-Less Core (Not Pictured)
Key Blank(Control & Operating)-**RESTRICTED***

*ALL Everest SFIC (Everest B Family) keyways are restricted. Call for details.

©ZIPF LOCK COMPANY

284 v1 SUPER SPECIAL PRICING AVAILABLE ON ITEMS MARKED WITH ■ - SUPPLIES LIMITED - PLEASE INQUIRE.
(PL-21)

CYLINDERS

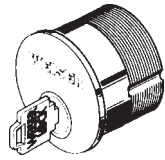

986 US-3
1-1/4" length
Mortise Cylinder

WEISER LOCK™

Discontinued by Weiser.
Call for closeout prices.

US-3 Bright Brass

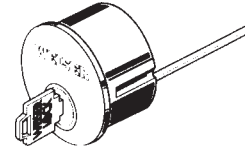

951 US-3
Rim Cylinder

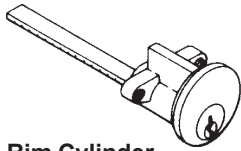

Rim Cylinder
\$1109 GC 4
GC Keyway, Satin Brass

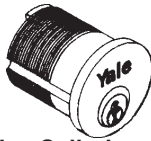

Mortise Cylinder
\$1152 1" GB 26D
GB Keyway, Satin Chrome

Yale

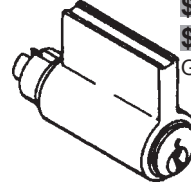

Knob Cylinder
\$1801 GC 4
\$1801 GE 4
GC or GE Keyway, Satin Brass

Knob Cylinder
\$1801 GC 26D
GC Keyway, Satin Chrome

For rim, mortise and knob cylinders with the Yale keyway see ILCO cylinders on pages 286-288.

SCHLAGE REPLACEMENT PLUGS

- **15316**-For all Schlage products except mortise, cabinet and F Series.
- **15215**-For Schlage B100, B200, B400 and H Series Deadlocks.
- Exact Tolerances.
- Solid Brass.
- Made in the U.S.A.

Stock No.	Application
15215-	5 Pin
15316-	6 Pin

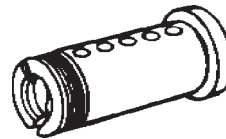

15215 5 Pin

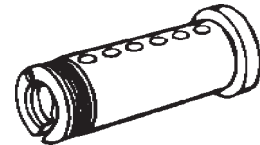

15316 6 Pin



TO ORDER, SPECIFY: **STOCK NO., KEYWAY & FINISH.** (EX: 15215-SC-26D)
(Schlage C, Satin Chrome)

KEYWAY CODES:	Finishes:
AA -Arrow (1179)	04, 26D
CA -Corbin 60 (1001EH)	04, 26D
KS -Kwikset (1176)	04, 26D

KEYWAY CODES:	Finishes:
RB -Russwin D1 (1011D1)	04, 26D
SC -Schlage C (1145)	04, 26D
SE -Schlage E (1145E)	04, 26D

KEYWAY CODES:	Finishes:
SX -Schlage C/K	04, 26D
XE -Dexter 67	04, 26D

PROFILE CYLINDERS

- Repinnable (chamber caps are set screws).
- Available in Kwikset or Schlage keyways.



Stock No.	Keyway
52225KS-04-KD	Kwikset
52225SC-04-KD	Schlage

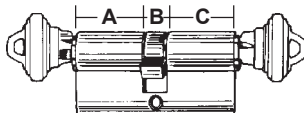

Stock No.	Keyway
53225KS-04-KD	Kwikset
53225SC-04-KD	Schlage

Dimensions: 28mm(A) x 10mm(B) x 28mm(C)

ZINC RIM CYLINDERS

- 5 pin tumber mechanism
- Furnished with trim ring, mounting plate and screws
- Horizontal or vertical applications.
- Only available KD, KA2 or KA10 box packed.

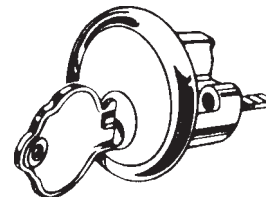

Stock No.	Keyway
605KW-04-41	Kwikset (*composite-1st pin at .248")
605SC-04-41	Schlage (**composite-1st pin at .231")

*Can be rekeyed to OEM Kwikset, Segal, Arrow, Weiser and many others.
**Can be rekeyed to OEM Schlage sections C-K.

Specify Keying — **KD, KA2 or KA10**

©ZIPF LOCK COMPANY

SUPER SPECIAL PRICING AVAILABLE ON ITEMS MARKED WITH ■ - SUPPLIES LIMITED - PLEASE INQUIRE.

285 v2
(PL-21)

CYLINDERS

REPLACEMENT CYLINDERS



BRASS RIM CYLINDERS

Precision Solid Bar Brass.

1-3/4" tailpiece can be converted to vertical applications. ILCO Look-Alike keys. Packaged with break-off screws, backplate, cylinder ring. Rekeyable to original manufacturers' systems.



6 pin,
keyed to 5 pin

(7075 was 7015)

TO ORDER:

Specify:

- 7075KS 8 - 26D**
1. Model No. _____
 2. Keyway Code _____
 3. Cam Code* _____
 4. Finish Code _____

* Comes with #8: 1-3/4" std tailpiece only.

Finish Codes:

- 03 Bright Brass
- 10B Oil-Rubbed Bronze
- 26D Satin Chrome
- 46 Duracolor

KEYWAY CODES:

AA -Arrow (1179)	03, 26D
CA -Corbin 60 (1001EH)	26D
CD -Corbin 59A1-A2	26D
CE -Corbin Russwin L4	26D
GA -Sargent LA (1007LA)	03, 26D
GB -Sargent LA-LC	26D
GC -Sargent RA-RC	26D
KS -Kwikset (1176)	03, 26D, 46

Finishes:

KEYWAY CODES:

LA -Lockwood 1004	26D
NB -Composite (HR1)	03, 26D
RA -Russwin 5981R (N1011P)	03, 26D
RB -Russwin D1 (1011D1)	03, 26D
SC -Schlage C (1145)	03, 10B, 26D, 46
SE -Schlage E (1145E)	10B, 26D
SX -Schlage C/K	03, 26D, 46
UE -Lori 80	26D

Finishes:

KEYWAY CODES:

WA -Weiser 1555	03, 26D
YA -Yale 8	03, 26D, 46
YG -Yale GA	26D

Finishes:

1" BRASS MORTISE CYLINDERS

Precision Solid Bar Brass. Standard diameter and thread. ILCO Look-Alike keys. Keyed to 5 pins.



TO ORDER:

Specify:

- 7165 KS 2 - 26D (1")**
1. Model No. _____
 2. Keyway Code _____
 3. Cam Code* _____
 4. Finish Code _____

*Cylinder has #2-Adams-Rite Cam.

Finish Codes:

- 03 Bright Brass
- 03P Bright Brass Permanent
- 04 Satin Brass
- 26D Satin Chrome
- 46 Duracolor

KEYWAY CODES:

AA -Arrow (1179)	03, 26D, 46
CA -Corbin 60 (1001EH)	26D
CE -Corbin Russwin L4	03
FA -Segal 9 (1022)	03, 46
GA -Sargent LA (1007LA)	26D
KS -Kwikset (1176)	03, 03P, 26D, 46
LA -Lockwood 1004	26D

Finishes:

KEYWAY CODES:

NB -Composite (HR1)	03, 26D
RA -Russwin 5981R (N1011P)	26D
RB -Russwin D1 (1011D1)	26D
SC -Schlage C (1145)	03, 03P, 26D, 46
SE -Schlage E (1145E)	04, 26D
SX -Schlage C/K	26D, 46
UA -Ilco X1054K	03

Finishes:

KEYWAY CODES:

WA -Weiser 1555	26D, 46
YA -Yale 8	03, 03P, 26D, 46

Finishes:

With BumpHalt™ pins:

BH-7165SC2-46

See page 289 for more information.

1-1/8" BRASS MORTISE CYLINDERS

Precision Solid Bar Brass. Standard diameter and thread. ILCO Look-Alike keys. Drilled for 6 pin, keyed to 5 pins.



TO ORDER:

Specify:

- 7185 KS 1 - 26D (1-1/8")**
1. Model No. _____
 2. Keyway Code _____
 3. Cam Code* _____
 4. Finish Code _____

*Cylinder has #1-Standard cam furnished.

Finish Codes:

- 03 Bright Brass
- 10B Oil-Rubbed Bronze
- 26D Satin Chrome
- 46 Duracolor

KEYWAY CODES:

AA -Arrow (1179)	03, 26D, 46
CA -Corbin 60 (1001EH)	26D
CD -Corbin 59A1-A2	03, 26D
CE -Corbin Russwin L4	03, 26D, 46
FA -Segal 9 (1022)	46
GA -Sargent LA (1007LA)	26D, 46
GB -Sargent LA-LC	03, 26D
GC -Sargent RA-RC	03, 26D

Finishes:

KEYWAY CODES:

KS -Kwikset (1176)	03, 26D, 46
NB -Composite (HR1)	26D
RA -Russwin 5981R (N1011P)	26D
RB -Russwin D1 (1011D1)	26D
SC -Schlage C (1145)	03, 26D, 46
SE -Schlage E (1145E)	03, 26D
SX -Schlage C/K	03, 10B, 26D, 46
UA -Ilco X1054K	03, 26D, 46

Finishes:

KEYWAY CODES:

UE -Lori 80	26D
WA -Weiser 1555	03, 26D, 46
YA -Yale 8	03, 10B, 26D, 46
YG -Yale GA	03, 26D

Finishes:

See Next Page For 1-1/4" Mortise, Turnknob and Dummy Cylinders.

CYLINDERS

REPLACEMENT CYLINDERS



1-1/4" BRASS MORTISE CYLINDERS

Precision Solid Bar Brass. Standard diameter and thread. ILCO Look-Alike keys. Drilled for 7 pin, keyed to 5 pins.



TO ORDER:

Specify: **7205 KS 1 - 26D (1-1/4")**

1. Model No. _____
 2. Keyway Code _____
 3. Cam Code.* _____
 4. Finish Code. _____

Finish Codes:

03 Bright Brass
 04 Satin Brass
 26D Satin Chrome

*Cylinder has #1-Standard cam furnished.

KEYWAY CODES:

Finishes:

AA-Arrow (1179) 03, 26D
 CA-Corbin 60 (1001EH) 03
 CE-Corbin Russwin L4 03
 FA-Segal 9 (1022) 03, 26D
 GA-Sargent LA (1007LA) 03, 26D
 GB-Sargent LA-LC 03, 26D

KEYWAY CODES:

Finishes:

GC-Sargent RA-RC 03, 26D
 KS-Kwikset (1176) 03, 26D
 LA-Lockwood 1004 26D
 RA-Russwin 5981R (N1011P) 04
 RB-Russwin D1 (1011D1) 03, 26D
 SC-Schlage C (1145) 03, 26D

KEYWAY CODES:

Finishes:

SE-Schlage E (1145E) 26D
 SX-Schlage C/K 26D
 UA-Ilco X1054K 03, 26D
 WA-Weiser 1555 03, 26D
 YA-Yale 8 03, 26D
 YG-Yale GA 03, 26D

TURNKNOB MORTISE CYLINDERS

Precision Solid Bar Brass. Standard diameter. 3 lengths available.



Stock No.	Description	Finishes
7161TK2	1" Turn Knob, A/R cam	03, 10B, 26D, 46
7181TK1	1-1/8" Turn Knob, std cam	03, 10B, 26D, 46
7201TK1	1-1/4" Turn Knob, std cam	03, 26D

TO ORDER, SPECIFY:

STOCK NO. & FINISH. (EX: 7161TK2-26D, 1" turn knob, satin chrome)

Finish Codes:

03 Bright Brass
 10B Oil-Rubbed Bronze
 26D Satin Chrome
 46 Duracolor

ADA TURNKNOB MORTISE CYLINDERS

Precision Solid Bar Brass. Standard diameter. 2 lengths available.



Stock No.	Description	Finishes
ADA7161-2	1" Turn Knob, A/R cam	03, 10B, 26D
ADA7181-1	1-1/8" Turn Knob, std cam	03, 10B, 26D

TO ORDER, SPECIFY:

STOCK NO. & FINISH. (EX: ADA7161-2-26D, 1" turn knob, satin chrome)

Finish Codes:

03 Bright Brass
 10B Oil-Rubbed Bronze
 26D Satin Chrome

DUMMY MORTISE CYLINDERS

Precision Solid Bar Brass. Standard diameter. 3 lengths available.



Stock No.	Description	Finishes
7160DC	1" Dummy	03, 26D, 46
7180DC	1-1/8" Dummy	03, 26D, 46
7200DC	1-1/4" Dummy	03, 26D

TO ORDER, SPECIFY:

STOCK NO. & FINISH. (EX: 7160DC-46, 1" dummy, Duracolor)

Finish Codes:

03 Bright Brass
 26D Satin Chrome
 46 Duracolor

DUMMY RIM CYLINDER

Precision Solid Bar Brass. Standard diameter.



Stock No.	Description	Finishes
7010DC	Dummy Rim	26D

TO ORDER, SPECIFY:

STOCK NO. & FINISH. (EX: 7010DC-26D, dummy rim, satin chrome)

Finish Codes:

26D Satin Chrome

©ZIPF LOCK COMPANY

SUPER SPECIAL PRICING AVAILABLE ON ITEMS MARKED WITH ■ - SUPPLIES LIMITED - PLEASE INQUIRE.

CYLINDERS

KEY-IN-KNOB REPLACEMENT CYLINDERS



UNIVERSAL KNOB/LEVER LOCKSET PLUS ARROW & SCHLAGE DEADBOLTS

- For Arrow D, E, F, K, Schlage B100, B200, B400, H Series.
- Operates most Grade 1 & 2 knob cylinder locksets and leversets (**Use 15395 for Arrow TA, BD, DD designs**).
- Screw cap retainer.
- 6 tailpieces included.
- 5 pin (drilled for 6 pins)
- Solid Brass.

With BumpHalt™ pins:

BH-15995KS-26D

BH-15995WA-26D

See next page for more information.



Finish Codes:

04 Satin Brass

26D Satin Chrome

Stock No. Application
15995- Arrow, Schlage

TO ORDER, SPECIFY:

STOCK NO., KEYWAY & FINISH. (EX: 15995-SC-26D (Schlage C, Satin Chrome))

KEYWAY CODES:

Finishes:

AA-Arrow (1179)	04, 26D
CA-Corbin 60 (1001EH)	04, 26D
CD-Corbin 59A1-A2	04, 26D
CE-Corbin Russwin L4	04, 26D
GA-Sargent LA (1007LA)	04, 26D
GB-Sargent LA-LC	04, 26D
GC-Sargent RA-RC	04, 26D

KEYWAY CODES:

Finishes:

KS-Kwikset (1176)	04, 26D
LA-Lockwood 1004	26D
NB-Composite (HR1)	04, 26D
RA-Russwin 5981R (N1011P)	04, 26D
RB-Russwin D1 (1011D1)	04, 26D
SC-Schlage C (1145)	04, 26D
SE-Schlage E (1145E)	04, 26D

KEYWAY CODES:

Finishes:

SF-Schlage F (1145F)	04, 26D
SX-Schlage C/K	04, 26D
UE-Lori (Kaba) 80 5 pin only	26D
WA-Weiser 1555*	04, 26D
XE-Dexter 67	04, 26D
YA-Yale 8	04, 26D
YG-Yale GA	04, 26D

UNIVERSAL KNOB/LEVER LOCKSET PLUS ARROW TA, BD, DD KNOB CYL.

- For Arrow TA, BD DD knob cylinders.
- Operates most Grade 1 & 2 knob cylinder locksets and leversets.
- 5 pin (drilled for 6 pins)
- Solid Brass.
- 3 tailpieces included.**

Finish Codes:

04 Satin Brass

26D Satin Chrome

Stock No. Application
15395- Universal

TO ORDER, SPECIFY:

STOCK NO., KEYWAY & FINISH. (EX: 15395-SC-26D (Schlage C, Satin Chrome))



KEYWAY CODES:

Finishes:

AA-Arrow (1179)	26D
CA-Corbin 60 (1001EH)	04, 26D
CD-Corbin 59A1-A2	26D
CE-Corbin Russwin L4	04, 26D
FA-Segal 9 (1022)	04, 26D
GA-Sargent LA (1007LA)	04, 26D
GB-Sargent LA-LC	26D

KEYWAY CODES:

Finishes:

KS-Kwikset (1176)	04, 26D
RA-Russwin 5981R (N1011P)	04, 26D
RB-Russwin D1 (1011D1)	04, 26D
SC-Schlage C (1145)	04, 26D
SE-Schlage E (1145E)	04, 26D
SX-Schlage C/K	26D
UA-Ilco X1054K	04, 26D

KEYWAY CODES:

Finishes:

UE-Lori 80	04, 26D
WA-Weiser 1555*	04, 26D
XE-Dexter 67	04, 26D
YA-Yale 8	04, 26D
YG-Yale GA	26D

KEY-IN-KNOB REPLACEMENT CYLINDERS FOR YALE KNOB/LEVER LOCKSETS

- For Yale knob/lever locks.
- 5 pin (drilled for 6 pin)
- Solid Brass.

Stock No. Application
15245- Yale 5400, 5300LN Series
15255- Yale Knob Series

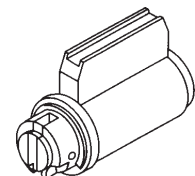

KEYWAY CODES:

Finishes:

AA-Arrow (1179) <i>Not 15245</i>	04, 26D
CA-Corbin 60 (1001EH)	04, 26D
CE-Corbin Russwin L4	04, 26D
RB-Russwin D1 (1011D1)	04, 26D

KEYWAY CODES:

Finishes:

SC-Schlage C (1145)	04, 26D
SE-Schlage E (1145E)	04, 26D
SX-Schlage C/K	04, 26D

TO ORDER, SPECIFY:

STOCK NO., KEYWAY & FINISH.

(EX: 15245-SC-26D

(Schlage C, Satin Chrome))

CYLINDERS

BUMP HALT CYLINDER KITS



These kits will enable the conversion of a new or existing Ilco cylinder to be "bump resistant". Cost effective and effective. No special tools and/or machining is required. Conversion kits contain 10 pins, 10 springs and instructions. One spring and one pin will provide resistance to "bumping"; adding an additional pin and spring will increase the security. Bump Halt has not been tested on competitive brands of cylinders.



Stock No.	Description
IL-1500BH-00-10	For Key-in-Knob/Lever Cylinders
IL-7000BH-00-10	For Mortise & Rim Cylinders



**Bump Keying - a technique using specially cut keys that can defeat conventional pin tumbler locks.*

CYLINDER RINGS AND COLLARS

STOCK NO. DESCRIPTION

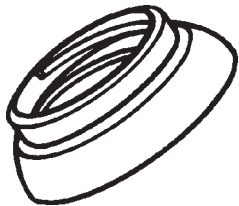

ADJUSTABLE SPRING COLLARS—

IL-861A-03-10	Bright Brass-Solid Brass, 5/16" to 13/32" adjustment
IL-861A-25-10	Satin Chrome-Solid Brass, 5/16" to 13/32" adjustment
IL-861U-03-10	Bright Brass-Steel Plated, 5/16" to 13/32" adjustment

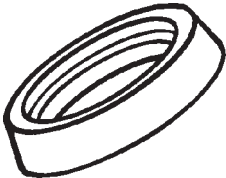

HARDENED COLLARS—

IL-861B-03-41	Tapered Hardened Collar, 7/16" projection, head recess 1/4", bevel angle 12°, Bright Brass Finish.
IL-861B-25-41	Same as IL-861B-03-41 but in Satin Chrome Finish.
IL-861W-03-41	Tapered Hardened Collar, 5/16" projection, head recess 5/32", bevel angle 70°, Bright Brass Finish.

ALUMINUM MORTISE CYLINDER SPACING COLLARS—

(Specify Finish)

IL-861C-xx-10	3/32" Aluminum Collar	03 , 28, 46
IL-861D-xx-10	1/8" Aluminum Collar	03, 28, 46
IL-861E-xx-10	5/32" Aluminum Collar	28, 46
IL-861L-xx-10	7/32" Aluminum Collar	03 , 28, 46
IL-861F-xx-10	1/4" Aluminum Collar	03, 28, 46
IL-861M-03-10	9/32" Aluminum Collar	
IL-861M-28-10	9/32" Aluminum Collar	
IL-861N-28-10	5/16" Aluminum Collar	
IL-861P-xx-10	11/32" Aluminum Collar	03 , 28, 46
IL-861Q-xx-10	3/8" Aluminum Collar	03 , 28, 46
IL-861R-xx-10	1/2" Aluminum Collar	03, 28, 46
IL-861T-xx-10	5/8" Aluminum Collar	03, 28, 46

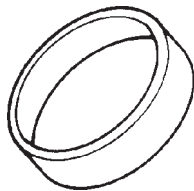

xx = Finish:
03 Bright Brass
28 Aluminum
46 Duracolor

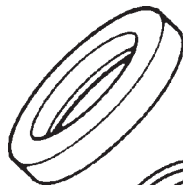

VINYL RING—

IL-861K-00-10	3/16" Grey Vinyl Ring
----------------------	-----------------------

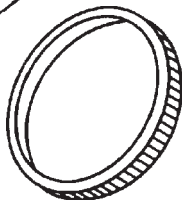

CASH BOX NUT - FOR MORTISE CYLINDERS—

IL-869-00-10	Cash Box Nut - Fits thread on standard mortise cylinder
---------------------	---

©ZIPF LOCK COMPANY

SUPER SPECIAL PRICING AVAILABLE ON ITEMS MARKED WITH ■ - SUPPLIES LIMITED - PLEASE INQUIRE.

289_{v1}
 (PL-21)

CYLINDERS

CYLINDER ACCESSORIES

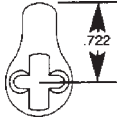

IL-863-00-10

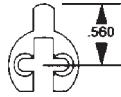

IL-863A-00-10

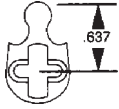

IL-863M-00-10

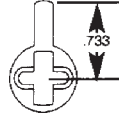

IL-863N-00-10

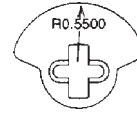

IL-863R-00-10

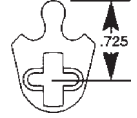

IL-863S-00-10

STOCK NO. DESCRIPTION

MORTISE CYLINDER CAMS

- IL-863-00-10 Yale Cam
- IL-863A-00-10 Adams Rite Cam
- IL-863G-00-10 Standard Cam
- IL-863M-00-10 Schlage "L" Cam
- IL-863N-00-10 Sargent/Yale Cam
- IL-863R-00-10 Lori Deadbolt
- IL-863S-00-10 Corbin/Russwin/Best Cloverleaf



IL-863G-00-10



IL-862-00-10

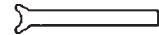

IL-862A-00-10

Tailpieces

- IL-862-00-10 Standard Break-off Screw 12-24 x 1-3/4"
- IL-862A-00-10 Extra Long Tailpiece 2-3/8"