

DOOR & CYLINDER GUARDS

LATCH PROTECTORS

The INTERLOCK for inswinging doors

Stock No.	Size	Finish
DJ-ILP206 SL	6"	Silver Coated
DJ-ILP206 DU	6"	Duro Coated
DJ-ILP206 BP	6"	Brass Plated
DJ-ILP212 SL	12"	Silver Coated
DJ-ILP212 DU	12"	Duro Coated
DJ-ILP212 BP	12"	Brass Plated

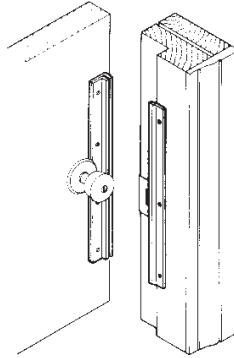

DON-JO

- 6" version for use with key-in-knob and deadbolt locks.
- 12" version for use with mortise locks, Simplex 1000 series, Alarm Lock DL-2500, DL-2700 & DL-3000, Card Access Systems, etc.
- 14 ga. (.075) Steel.

For Aluminum Entrance Doors

Stock No.	Finish
DJ-LP307 DU	Duro Coated
DJ-LP307 SL	Silver Coated

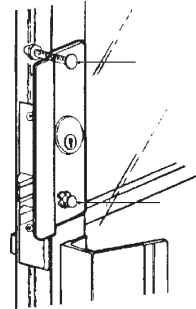

- Reversible.
- Fits over cylinder, lock removal NOT required.
- Hand carriage bolt and rivet supplied.
- No specific tools required.
- 3/8" offset.
- 2-5/8" x 7" x 1/8".
- 12 ga. (.104) Steel.

For Aluminum Entrance Doors - solves pull handle interference

Stock No.	Finish
DJ-GLP307 DU	Duro Coated

Specify Hand: LHR or RHR
(LHR shown in picture)

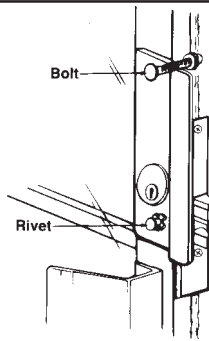

- Handed: LHR or RHR.
- Fits over cylinder, lock removal NOT required.
- Hand carriage bolt and rivet supplied.
- No specific tools required.
- 3/8" offset.
- 2-5/8" x 7" x 1/8".
- 12 ga. (.104) Steel.
- Center of cylinder hole is 2-1/2" from end of plate.

For Center Hung Outswinging Aluminum Doors

Stock No.	Finish	Offset
DJ-OLP2650DU	Duro Coated	1-1/8"
DJ-OLP2651DU	Duro Coated	1-3/8"
DJ-OLP2651SL	Silver Coated	1-3/8"

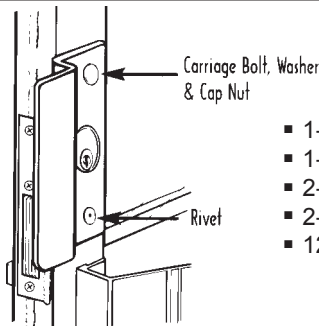

- 1-1/8" offset (OLP-2650).
- 1-3/8" offset (OLP-2651).
- 2-5/8" x 6-1/2" x 1/8" (OLP-2650).
- 2-5/8" x 6-1/2" x 3/8" (OLP-2651).
- 12 ga. (.104) Steel.

For Outswinging Doors - completely covers the strike plate

Stock No.	Finish
DJ-MLP111 630	Stainless Steel
DJ-MLP211 BP	Brass Plated
DJ-MLP211 DU	Duro Coated
DJ-MLP211 SL	Silver Coated

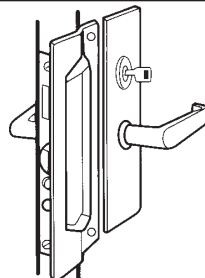

- Furnished with carriage bolts, washers & acorn nut for safety and strength.
- 3" x 11".
- 12 ga. (.104) Steel

306 v1

SUPER SPECIAL PRICING AVAILABLE ON ITEMS MARKED WITH ■ - SUPPLIES LIMITED - PLEASE INQUIRE.

(PL-24)

©ZIPF LOCK COMPANY

DOOR & CYLINDER GUARDS

LATCH PROTECTORS

DON-JO

For Outswinging Doors - completely covers the strike plate

Stock No.	Finish
DJ-LP111 630	Stainless Steel
DJ-LP211 BP	Brass Plated
DJ-LP211 DU	Duro Coated
*DJ-9211 DU	Duro Coated
DJ-LP211 PC	Prime Coated
*DJ-9211 PC	Prime Coated
DJ-LP211 SL	Silver Coated

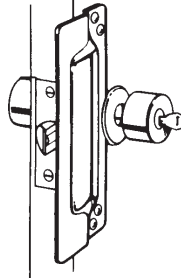

- Furnished with carriage bolts, washers & acorn cap nuts.
- 3" x 11"
- Fits 2-3/4" and 2-3/8" backsets.
- 12 ga. (.104) Steel.

***SAVE MONEY: DJ-9211 are poly-bagged and sold in multiples of 10.**

Pin Latch Protector for Outswinging Doors

Stock No.	Finish
DJ-PLP111 630	Stainless Steel
DJ-PLP211 BP	Brass Plated
DJ-PLP211 DU	Duro Coated
DJ-PLP211 SL	Silver Coated
DJ-PLP211 626	Satin Chrome



- Solid steel pin prevents spreading of door from frame.
- Pin is welded on back leaving no visible point of attack from outside.
- Fits 2-3/4" and 2-3/8" backset.
- 3" x 11".
- 12 ga. (.104) Steel

Pin Latch Protector for Outswinging Doors

Stock No.	Finish
DJ-PMLP111 630	Stainless Steel
DJ-PMLP211 BP	Brass Plated
DJ-PMLP211 DU	Duro Coated
DJ-PMLP211 SL	Silver Coated

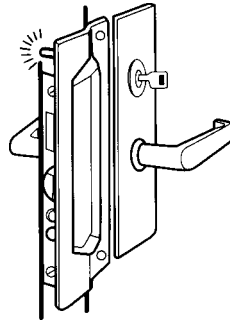

- Solid steel pin prevents spreading of door from frame.
- Pin is welded on back leaving no visible point of attack from outside.
- Fits 2-3/4" and 2-3/8" backset.
- 3" x 11".
- 12 ga. (.104) Steel

For Outswinging Doors

Stock No.	Finish
DJ-LP107 630	Stainless Steel
DJ-LP207 BP	Brass Plated
DJ-LP207 SL	Silver Coated
DJ-LP207 DU	Duro Coated



- Furnished with carriage bolts, washers & acorn cap nuts.
- 2-3/4" x 7"
- 12 ga. (.104) Steel

Commercial Type For Outswinging Doors

Stock No.	Finish	Dimensions
DJ-CLP106 630	Stainless Steel	2-1/8" x 6"
DJ-CLP110 630	Stainless Steel	2-1/8" x 10"

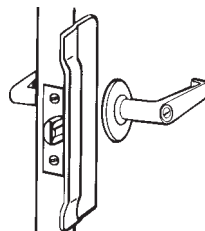

- 6" for key-in-knobs.
- 10" for mortise locks.
- Architectural design.
- Concealed welded studs with fasteners.
- 12 ga. (.104) Steel

©ZIPF LOCK COMPANY

SUPER SPECIAL PRICING AVAILABLE ON ITEMS MARKED WITH ■ - SUPPLIES LIMITED - PLEASE INQUIRE.

307_{v2}
(PL-24)

DOOR & CYLINDER GUARDS

LATCH PROTECTORS

DON-JO

Narrow Commercial Type For Outswinging Doors

Stock No.	Size	Finish
DJ-NLP206 DU	6"	Duro Coated
DJ-NLP206 PC	6"	Prime Coated
DJ-NLP206 SL	6"	Silver Coated
DJ-NLP110 630	10"	Stainless Steel
DJ-NLP210 DU	10"	Duro Coated
DJ-NLP210 PC	10"	Prime Coated
DJ-NLP210 SL	10"	Silver Coated



- 6" for key-in-knob.
- 10" for mortise locks.
- Narrow type for outswinging doors.
- NLP106: 1-1/2" x 6"
- NLP110: 1-1/2" x 10"
- NLP206: 1-1/2" x 6"
- NLP210: 1-1/2" x 10"
- 12 ga. (.104) Steel.

For Key-In-Lever with up to 3-3/4" escutcheon

Stock No.	Finish
DJ-BLP107 630	Stainless Steel
DJ-BLP207 BP	Steel Brass Plated
DJ-BLP207 DU	Duro Coated
DJ-BLP207 SL	Silver Coated

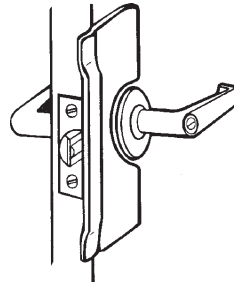

- Works with up to 3-3/4" rose.
- Fits most heavy duty key-in-lever locks.
- Concealed welded studs and fasteners.
- 3-1/4" x 7".
- 12 ga. (.104) Steel.

For Electronic Locks

Stock No.	Finish
DJ-KLP110 LH 630	Stainless Steel
DJ-KLP110 RH 630	Stainless Steel

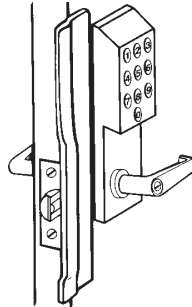

- Works with ILCO 1000, 4000 locks.
- Alarm Lock Trilogy locks.
- Mas-Hamilton Power Levers.
- Schlage Cobra locks.
- 1-1/2" x 10".
- 12 ga. (.104) Steel.

Angle Type for Outswinging Doors

Stock No.	Size	Finish
DJ-ALP206 BC	6"	Brass Coated
DJ-ALP206 DU	6"	Duro Coated
DJ-ALP206 SL	6"	Silver Coated
DJ-ALP210 BC	10"	Brass Coated
DJ-ALP210 DU	10"	Duro Coated
DJ-ALP210 SL	10"	Silver Coated

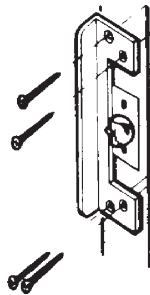

- 6" for key-in-knob.
- 10" for mortise locks.
- 1-1/2" sheet metal screws for wood or metal.
- 10 ga. (.134) Steel

For use with Electric Strikes

Stock No.	Finish
DJ-ELP208 DU	Duro Coated
DJ-ELP208 SL	Silver Coated
DJ-ELP208P DU*	Duro Coated
DJ-ELP208P SL*	Silver Coated

*Without cylinder hole.

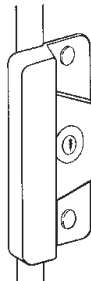

- Available with or without cylinder hole.
- Designed to fit most electric strikes.
- Completely encases the keeper for maximum protection.
- 3-1/2" x 8".
- 12 ga. (.104) Steel.

©ZIPF LOCK COMPANY

308_{v1} SUPER SPECIAL PRICING AVAILABLE ON ITEMS MARKED WITH ■ - SUPPLIES LIMITED - PLEASE INQUIRE.
(PL-24)

DOOR & CYLINDER GUARDS

LATCH PROTECTORS

DON-JO

Fits Folger Adams Electric Strike - for outswinging doors.

Stock No.
DJ-FLP111 SL

Finish
Silver Coated

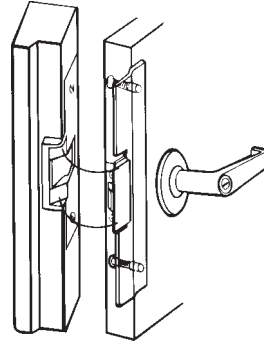

- Works with Folger Adams 310 & 710.
- 1-3/4" x 11-1/4".
- 12 ga. (.104) Steel.

Short Type for Outswinging Doors

Stock No.
DJ-SLP206 BP
DJ-SLP206 SL
DJ-SLP206 DU

Finish
Brass Plated
Silver Coated
Duro Coated

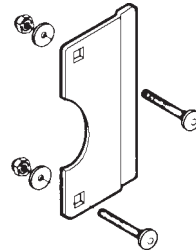

- Furnished with carriage bolts, washers & acorn cap nuts for safety & strength.
- May be used on hollow metal door/frame using ANSI strike.
- Works with up to 3-3/4" rose.
- 2-1/2" x 6"
- 12 ga. (.104) Steel

Slimline for Outswinging Doors

Stock No.
DJ-LP2878 DU
DJ-LP2878 PC
DJ-LP2878 SL

Finish
Duro Coated
Prime Coated
Silver Coated



- Fasteners Included.
- Sleek Appearance.
- 1-1/2" x 8-7/8" x 5/16".
- 5/16" thick (.3125) Steel.

Fits Adams Rite Latch Lock for outswinging doors

Stock No.
DJ-LP312 DU
DJ-LP312 SL
DJ-LP312P DU*
DJ-LP312P SL*

Finish
Duro Coated
Silver Plated
Duro Coated
Silver Coated

* No Center Hole

DJ-LP312P supplied without 1-7/16" hole. Allows installer to drill hole for custom applications.

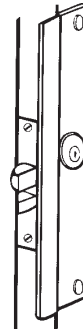

- Reversible.
- 1/4" Offset.
- 1-7/16" Hole (also available w/o hole).
- 1-1/8" Backset.
- 2-5/8" X 12" X 1/8".
- 12 ga. (.104) Steel.

ALUMINUM DOOR SECURITY

KEDIX

CYLINDER GUARD RING—K-24

Hardened steel, free spinning, tapered cone shaped cylinder guard. Works with both 5 and 6 pin cylinders. Kit includes 6 of each: ring, stainless steel wave washer and spacing collar.

Stock No.
KD-K-24A ALUM
KD-K-24B DURA

Finish
Aluminum Finish
Duranotic Finish

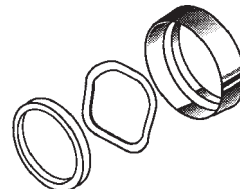

©ZIPF LOCK COMPANY

SUPER SPECIAL PRICING AVAILABLE ON ITEMS MARKED WITH ■ - SUPPLIES LIMITED - PLEASE INQUIRE.

309_{v2}
(PL-24)

DOOR & CYLINDER GUARDS

ALUMINUM DOOR SECURITY



STYLE GUARD—K-9/K-21

Made of 12 gauge steel, Style Guard reinforces or repairs aluminum-stile doors. 8" long. KD-K-9 for standard 4" jamba and KD-K-21 for 4-1/2" jamba. Designed with a "knock-out" to accommodate either the W&F or the Adams Rite bolt. Baked on enamel-type finish matches nicely for a professional looking job.

Stock No.	Length	Finish
KD-K-9A 626	4"	Aluminum Finish
KD-K-9B 613	4"	Duronotic Finish
KD-K-21B 613	4-1/2"	Duronotic Finish

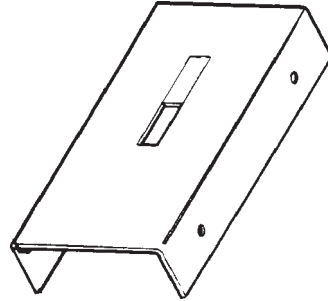

DOUBLE DOOR STYLE GUARD—K-15

Finally a better way to secure a set of double aluminum doors!! 12 gauge steel increases security and can repair doors that have already been attacked. 7-3/4" long, for 1-3/4" doors. Designed with knock out feature to make a W&F into an Adams Rite

Stock No.	Finish
KD-K-15B 613	Duronotic Finish

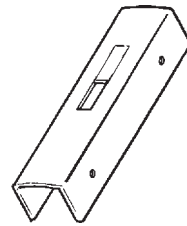

HEAVY DUTY GUARD PLATE

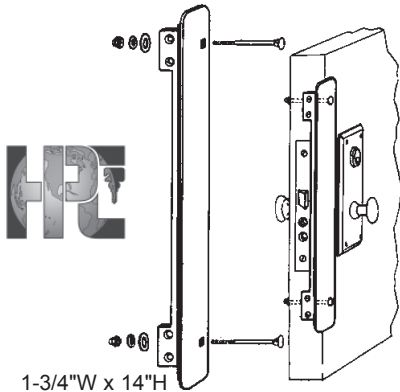

1-3/4"W x 14"H

VDG-10

The VDG-10 is the strongest and most popular guard plate. It is 14" long and is made from 2 pieces of 16 gauge cold rolled steel, welded together with a baked Matte Bronze finish.

This guard plate offers maximum resistance to prying and forcing. It mounts onto your door with 2 carriage bolts going through the door and anchored with a nut and cap nut on the inside. Four wood screws go into the edge of the door. Guard plates come complete with all necessary hardware and illustrated instructions.

DORGARD II FOR NARROW STILE ALUMINUM DOORS

Stock No.	Description
DG2-AXS-10	For 1" cylinder lengths
DG2-BXS-10	For 1-1/8" cylinder lengths

The DorGard II™ provides unsurpassed protection for lock cylinders on narrow stile aluminum doors. Using cast steel components, it creates a "vault" around the cylinder, virtually eliminating the possibility of unauthorized entry by removal of the cylinder or cylinder plug. The face plate is cast stainless steel, protecting against all common drilling equipment. The plug protector is made of case hardened steel. It rotates freely in the face plate, protecting against forcible removal of the plug. The DG2 is affixed with hardened steel bolts through the door. The unique construction provides easy installation, and easy access (without removing the door guard) for servicing the cylinder. DorGard II™ can be used with any cylinders from 15/16" to 13/8" (2.38 x 3.50cm) in length. Satin stainless finish. 1.5"W x 4.5"H.



Satin Stainless Finish

See next page for DorGard III

REMEMBER: If you don't see what you need, please contact us with your requirements.

©ZIPF LOCK COMPANY

310_{v2} SUPER SPECIAL PRICING AVAILABLE ON ITEMS MARKED WITH ■ - SUPPLIES LIMITED - PLEASE INQUIRE.
(PL-24)

DOOR & CYLINDER GUARDS

DORGARD III FOR NARROW STILE ALUMINUM DOORS



TK3 - Installation Kit

Contains 1 back plate, drill jig and 2 jamb hole locators and can be used for multiple installations.

Stock No.	Finishes
DG3-APD-10	Satin Stainless Steel
DG3-APS-10	Matte Bronze

A common problem with narrow stile aluminum doors is attack at the door jamb. An unprotected door is subject to a pry bar spreading the door and the jamb, or even ripping out the jamb, allowing unauthorized entry. Sawing the bolt has also been a means to gain unlawful entry. DorGard III™ will thwart all of these attempts, as well as guard the lock cylinder.

The DorGard III™ provides the same cylinder protection as the DorGard II™, **shown on previous page**, plus has the added benefit of a latch protection plate. This hardened steel plate becomes an integral part of the DorGard™ system. Cast in one piece, with ribs on the back for added strength, the latch plate has two pins that will rest in holes drilled into the door jamb. This innovative pin feature adds another level of security to the door by linking the door and the jamb together. The DorGard III™ is the perfect choice for electric strike applications; it adds security to the convenience of electric strikes. It completely conceals the area of the lock bolt and strike, and blocks all access to the lock and cylinder. **The DG3 can be used with any cylinders from 15/16" to 1-3/8" (2.38 x 3.50cm) in length.**

The DorGard III™ is non-handed so it can be used on right or left handed doors. Mounting hardware and illustrated installation instructions are included. HPC strongly suggest using their TK3 installation kit.



Same as DorGard II but has the added benefit of a latch protection plate.

PROTECT AGAINST
BREAK-INS!!

LATCH-GARD®

Finishes:
BB- Bright Brass
D- Duranodic
Z- Zinc Plated



3" x 11"
LG-100



3" x 11"
LG-110



1-1/2" x 6"
LG-120



1-1/2" x 10"
LG-130



2-1/2" x 10"
LG-140



2-5/8" x 6"
LG-150



12" x 2-5/8"
Fits Adams Rite
LG-160

1-7/8" x 12"

LG-170
3/8" offset

LG-171
1/2" offset



LG-700Z
(1/4" x 20 tpi)
with screw

LG-710Z
(5/16" x 18 tpi)
with screw

TO ORDER: Specify Guard No. and Finish.

LG-100 + BB = LG-100-BB

©ZIPF LOCK COMPANY

DOOR & CYLINDER GUARDS

MAG is no longer in business. Therefore, these items are in very limited supplies.



Stock No. **MAG-8843-C** **Finishes** Chrome
Latch Guard 12", for In-Opening doors. All backsets, Deadbolts and Key-in-knobs locks. Double locks, Mortise Locks & Access control locks. Reinforces door and frame, prevents spreading of frame, hardened coneaed screws. 14GA. U.S. Pat. 5,395,145

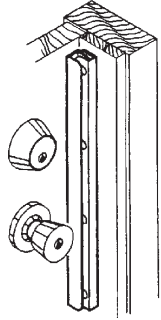

Stock No. **MAG-8845-B** **Finishes** Brass
Latch Guard 6", for Out-Opening doors. All backsets, Deadbolts and Key-in-knobs locks. Protects latch or bolt, heavy gauge steel. Accepts up to 3-1/2" rose, 7/16" offset. 12 GA.

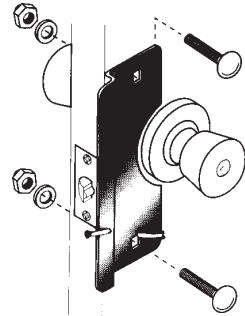

Stock No. **MAG-8848-C** **Finishes** Chrome
Latch Guard Heavy Duty 7", for Out-Opening doors. All backsets, Deadbolts and Key-in-knobs locks. Protects latch or bolt. Conceals lip if existing strike. Accepts up to 3-1/2" rose. 12 GA.

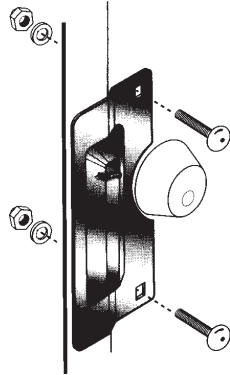

Stock No. **MAG-8854-AL** **Finishes** Aluminum
MAG-8854-DU Duronodic
Latch Guard 12", Removable (for flush doors). With anti-spread pins for single or double acting doors with cylinder guard. 12GA. U.S. Pat. 5,547,239.

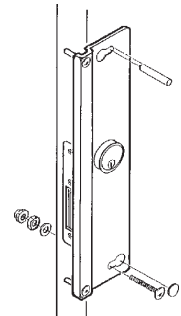

Stock No. **MAG-8855-AL** **Finishes** Aluminum
MAG-8855-DU Duronodic
Latch Guard 12", Removable (for center hung 4" frame). With anti-spread pins for center hung doors, 1-1/8" offset for 4" frame with cylinder guard, for single or double acting. 12GA. U.S. Pat. 5,547,239.

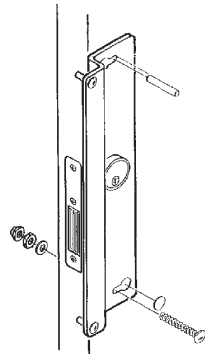

CAL-ROYAL

CR-LPG2
 Latch Guard
 Finishes:
 ALUM, DURO,
 GOLD, USP

2-7/8" x 11"

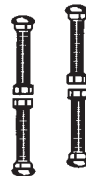
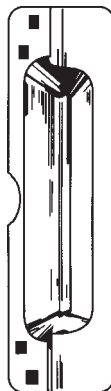

"THE BLOCKER"

Discontinued.
 Call for closeout prices

Application: The Blocker® discourages forced entry attempts on outswinging doors. 3" x 10-7/8"

Stock No. **\$LOR-1100 DU** **Finish** Duranodic

©ZIPF LOCK COMPANY