

CHEST, CUPBOARD & DRAWER LOCKS

Also be sure to check "DESK LOCKS" on pages 291-292 if you cannot find it here.

SPECIAL PURPOSE DRAWER & DOOR LOCK

CompX
CHICAGO

- Six disc tumbler plug in 3/4" diameter.
- Die Cast barrel with two flats—21/32" across.
- Key and cam rotation 90° from locked (12 O'clock) to unlocked (3 O'clock) position with keypull in both positions.
- This lock designed to be used with customer's latching mechanism.
- Standard finish: Satin Nickel.
- Two keys furnished per lock.

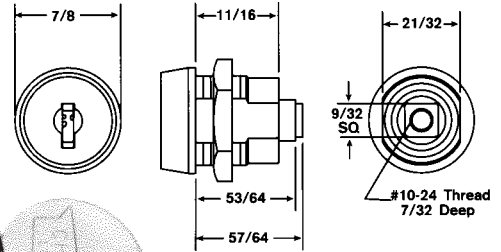
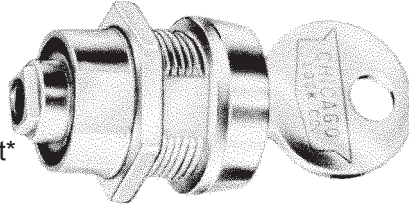

Stock No.
C17256TNH KV*

Keying
Keyed Different*

*KV indicates the majority of the quantity of locks will be keyed different. A lesser quantity will potentially be keyed alike to one or more key numbers. We can not guarantee that we can ship keyed DIFFERENT locks.

BOLT TYPE LOCKS

- Five Disc tumbler.
- Removable plug feature.
- Steel locking bolt.
- Furnished with two keys per lock.

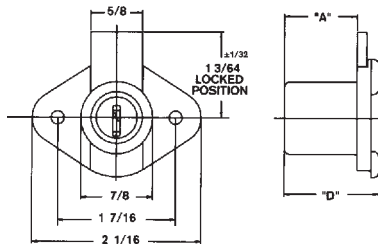

C1968

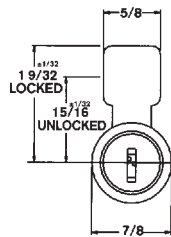

C1975

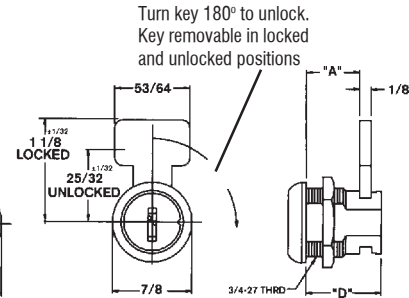

C1974

Stock No.	A	D	Finish	Keyed Alike Numbers Available
C1968	57/64"	1-5/32"	Brushed Brass	1289, 1454
C1974	19/32"	27/32"	Satin Chrome	1289
C1975	21/32"	57/64"	Satin Chrome	1289, 1454

Available **KV**-Keyed Different or **KA**-Keyed Alike. **Specify KV or KA**

*KV indicates the majority of the quantity of locks will be keyed different. A lesser quantity will potentially be keyed alike to one or more key numbers. We can not guarantee that we can ship keyed DIFFERENT locks.

**Need a Chicago item not shown?
Contact us with your needs.**

©ZIPF LOCK COMPANY

SUPER SPECIAL PRICING AVAILABLE ON ITEMS MARKED WITH ■ - SUPPLIES LIMITED - PLEASE INQUIRE.

259_{v1}
(PL-20)

CHEST, CUPBOARD & DRAWER LOCKS

Also be sure to check "DESK LOCKS" on pages 291-292 if you cannot find it here.

23000 SERIES SINGLE BITTED DRAWER LOCKS W/UNIVERSAL KEYWAY

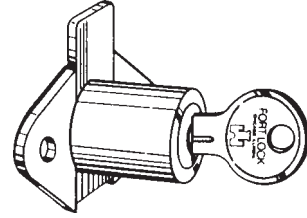

- Single bitted.
- Universal Keyway—K54G. (See next page)
- Multi-function—Latch & Deadlatch included.
- Keypull at 12:00 & 3:00.
- Finish: Brass or Stainless Steel.
- Two keys furnished per lock.

Stock No.	Finish	Barrel Length	Keyed Alike Numbers Available
MFW-23007	Stainless Steel	7/8"	221
MFW-23007B	Brass	7/8"	

Available **KD**-Keyed Different or **KA**-Keyed Alike. *Specify KD or KA*

23000 SERIES MULTI-FUNCTION METAL DRAWER LOCK w/UNIVERSAL KEYWAY

- Single bitted.
- Multi-function—2 bolt throw heights.
- Bolt notched for assembled installation.
- 90° key turn to open.
- Key removable locked or unlocked.
- Removable cylinder for rekeying.
- Finish: Brass or Stainless Steel.
- Two keys furnished per lock.

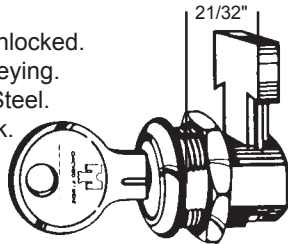

Stock No	Keying
MFW-23010 KD	Keyed Different
MFW-23010 KA	Keyed Alike—217, 237

1000 SERIES HIGH SECURITY TUBULAR DRAWER LOCK

- 7 pin tumbler.
- 3/8" bolt throw.
- Keypulls at 12:00 & 6:00.
- 180° key turn to open
- Standard finish: Chrome Plated.
- Two keys furnished per lock.

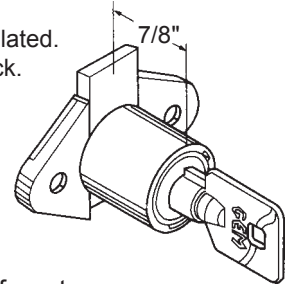

Discontinued. Call for closeout prices.

Stock No	Keying
DR-1008 KD	Keyed Different
DR-1008 KA	Keyed Alike—27379, 27380

DRAWER AND CABINET LOCKS

- Single bitted.
- Key removable at 12:00 & 6:00.
- Keyway: O1014S.
- 7/8" diameter.
- Brass finish.

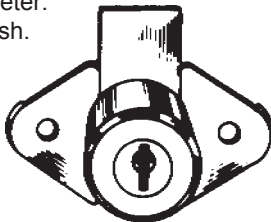

Stock No.	Barrel Length	Keyed Alike Number Available
1701-04-11	3/4"	
1702-04-11	7/8"	EB8 , EB72, EB78, EB92

Available **KD**-Keyed Different or **KA**-Keyed Alike.

Specify KV or KA

©ZIPF LOCK COMPANY

260_{v2}
(PL-20)

SUPER SPECIAL PRICING AVAILABLE ON ITEMS MARKED WITH ■ - SUPPLIES LIMITED - PLEASE INQUIRE.

CHEST, CUPBOARD & DRAWER LOCKS

Also be sure to check "DESK LOCKS" on pages 291-292 if you cannot find it here.

PIN TUMBLER DOOR AND DRAWER LOCKS

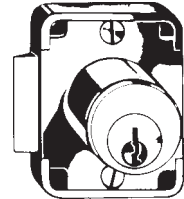
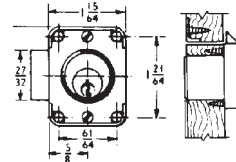
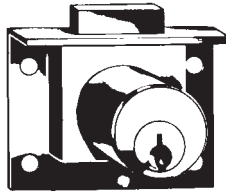
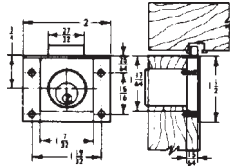
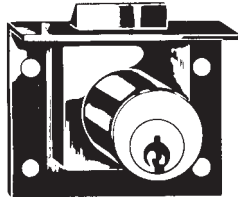

NL-C8131

NL-C8133
NL-C8135

NL-C8139

APPLICATION—For drawers. Half mortise type requires mortise for housing and 57/64" dia. hole for cylinder. NL-C8139 is surface mounted.

OPERATION—Key removable in both locked and unlocked positions except NL-C8131 and NL-C8139.

KEYING—Will key together with all other pin tumbler locks using D4291 key blank except NL-C8700 mail box locks. Available keyed different (**KD**) or keyed alike (**KA**).

KEY BLANK—D4291.

PACKAGING—Supplied with two keys, strike and mounting screws.

FINISHES—4-Satin Brass, 26D- Dull Chrome.

Stock #	Installation	Bolt Type	Cylinder Length	Bolt Travel	Keyed Alike Numbers Available
NL-C8131-4*	Drawer	Spring	7/8"	7/32"	107
NL-C8131-26D*	Drawer	Spring	7/8"	7/32"	107
NL-C8133-4	Drawer	Dead	7/8"	1/4"	107
NL-C8133-26D	Drawer	Dead	7/8"	1/4"	101, 107
NL-C8135-26D	Drawer	Dead	1-1/8"	1/4"	101, 107
NL-C8139-26D*	Door	Spring	3/4"	7/32"	915

*Key removable in locked position only.

Available **KD**-Keyed Different or **KA**-Keyed Alike. *Specify KD or KA*

PIN TUMBLER DOOR DRAWER LOCKS

APPLICATION—For center drawers of desks. Fits special piercing of drawer front and selvage (see drawing). Reinforced insertable dead bolt. Metal drawer, 1/4" Max. material thickness.

OPERATION—Key removable in both locked and unlocked positions.

KEYING—Will key together with all other pin tumbler locks using D4291 key blank except NL-C8700 mail box locks. Available keyed different (**KD**) or keyed alike (**KA**).

KEY BLANK—D4291.

PACKAGING—Supplied with two keys and mounting nut.

FINISHES—26D- Dull Chrome.

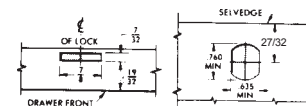

Mounting Holes

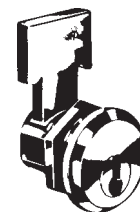

Stock #	Mounting or Installation	Bolt Type	Cylinder Length	Bolt Travel	Keyed Alike Number Available
NL-C8137-26D	Drawer	Reinforced, Insertable Dead Bolt	19/32"	7/16"	107, 915

Available **KD**-Keyed Different or **KA**-Keyed Alike. *Specify KD or KA*

©ZIPF LOCK COMPANY

SUPER SPECIAL PRICING AVAILABLE ON ITEMS MARKED WITH ■ - SUPPLIES LIMITED - PLEASE INQUIRE.

261^{v1}
(PL-20)

CHEST, CUPBOARD & DRAWER LOCKS

Also be sure to check "DESK LOCKS" on pages 291-292 if you cannot find it here.

PIN TUMBLER DOOR AND DRAWER LOCKS



APPLICATION—For drawers, RH or LH doors. Surface mounted. Requires 57/64" dia. hole for cylinder.

OPERATION—Key removable in both locked and unlocked positions.

KEYING—Will key together with all other pin tumbler locks using D4291 key blank except NL-C8700 mail box locks. Available keyed different (KD) or keyed alike (KA).

KEY BLANK—D4291.

PACKAGING—Supplied with two keys, strike and mounting screws.

FINISHES—4-Satin Brass, 4G-Antique Brass, 26D- Dull Chrome.

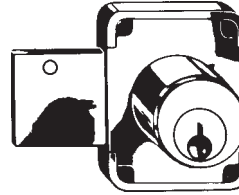
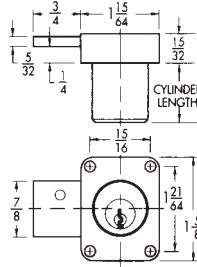

NL-C8173, NL-C8174, NL-C8175

"The Advantage Plus"

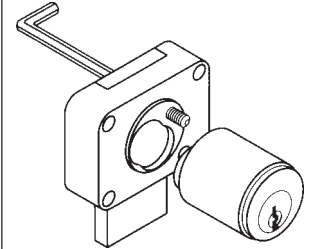

The PLUS feature allows you to remove the cylinder from these pin tumbler box locks while the lock remains in place. Simply use a 5/64" allen wrench from the back.

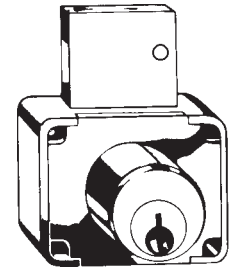
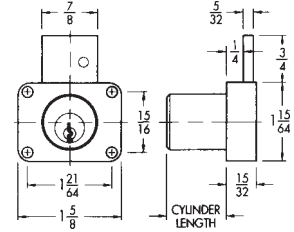

NL-C8177, NL-C8178, NL-C8179

Stock No.	Installation	Bolt Type	Cylinder Length	Bolt Travel	Keyed Alike Numbers Available
NL-C8173-4	Door	Dead	7/8"	3/4"	915
NL-C8173-4G	Door	Dead	7/8"	3/4"	915
NL-C8173-26D	Door	Dead	7/8"	3/4"	107, 915
NL-C8174-26D	Door	Dead	1-1/8"	3/4"	107
NL-C8175-26D	Door	Dead	1-3/8"	3/4"	107
NL-C8177-26D	Drawer	Dead	1-1/8"	3/4"	107
NL-C8178-4	Drawer	Dead	7/8"	3/4"	
NL-C8178-26D	Drawer	Dead	7/8"	3/4"	103, 915
NL-C8179-26D	Drawer	Dead	1-3/8"	3/4"	915

Available KD-Keyed Different or KA-Keyed Alike. *Specify KD or KA*

PIN TUMBLER DRAWER LOCKS

APPLICATION—For drawers. Surface mounted. Requires 57/64" dia. hole for cylinder.

OPERATION—Key removable in both locked and unlocked positions.

KEYING—Will key together with all other pin tumbler locks using D4291 key blank except NL-C8700 mail box locks. Available keyed different (KD) or keyed alike (KA).

KEY BLANK—D4291.

PACKAGING—Supplied with two keys and mounting screws.

FINISHES—4-Satin Brass, 26D- Dull Chrome.

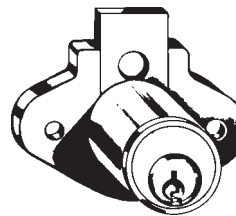

NL-C8163

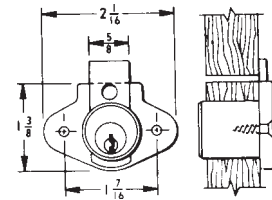

Stock No.	Installation	Bolt Type	Cylinder Length	Bolt Travel	Keyed Alike Number Avail.
NL-C8163-4	Drawer	Dead	15/16"	11/32"	101, 103, 107
NL-C8163-26D	Drawer	Dead	15/16"	11/32"	101, 915

Available KD-Keyed Different or KA-Keyed Alike. *Specify KD or KA*

"THE ADVANTAGE PLUS" NL-C8163 locks feature easy removal of cylinder from lock housing while lock remains in place. Bolt has access hole for cylinder retention screw at back of lock.

©ZIPF LOCK COMPANY

CHEST, CUPBOARD & DRAWER LOCKS

Also be sure to check "DESK LOCKS" on pages 291-292 if you cannot find it here.

PIN TUMBLER DRAWER LOCKS

APPLICATION—Replacement lock housing and cylinder for drawers with 7/8" thick fronts. Half mortise design.

OPERATION—Key removable in both locked and unlocked positions. Interchangeable cylinders are attached or removed through the use of a special key at back of lock.

KEYING—Keyed different (KD). 100 changes.

KEY BLANK—D4292 for the NL-C8160.

PACKAGING—NL-C8160 cylinder supplied with two keys. NL-C8161 lock housing supplied with cylinder removal key and mounting screws.

FINISHES—26-Bright Brass; 26D- Dull Chrome.

CompX
NATIONAL

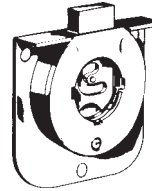

NL-C8161

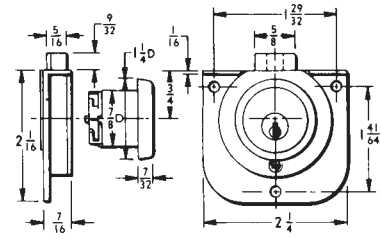

NL-C8160

Stock #	Mounting or Installation	Bolt Type	Min. Material Thickness	Bolt Travel	Keyed Alike Numbers Available
NL-C8160-26D	In Housing	—	—	—	—
NL-C8161-26	Drawer	Dead	7/8"	9/32"	—

DISC TUMBLER DRAWER LOCKS

APPLICATION—For center drawers of metal desks. Fits special piercing of drawer front and selvage (see drawing). 1/4" max. mat'l. thickness

OPERATION—Key removable in both locked and unlocked positions.

KEYING—Will key together with all other disc tumbler locks using D8785 key blank. Available keyed different (KD) or keyed alike (KA).

KEY BLANK—D8785.

PACKAGING—Supplied with two keys and mounting nut.

FINISHES—14A- Bright Nickel

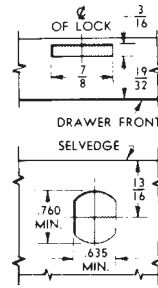

Stock #	Mounting or Installation	Bolt Type	Cylinder Length	Bolt Travel	Keyed Alike Numbers Available
NL-C8701-14A	Drawer*	Reinforced, Insertable Dead Bolt	19/32"	11/32"	C413A

*Metal drawer, 1/4" max. material thickness.

Available KD-Keyed Different or KA-Keyed Alike. Specify KD or KA

©ZIPF LOCK COMPANY

SUPER SPECIAL PRICING AVAILABLE ON ITEMS MARKED WITH ■ - SUPPLIES LIMITED - PLEASE INQUIRE.

263_{v1}
(PL-20)

CHEST, CUPBOARD & DRAWER LOCKS

Also be sure to check "DESK LOCKS" on pages 291-292 if you cannot find it here.

DISC TUMBLER DOOR AND DRAWER LOCKS



APPLICATION—For drawers and doors. Surface mounted. Requires 7/8" dia. hole for cylinder.

OPERATION—Key removable in both locked and unlocked positions, except NL-C8706.

KEYING—Will key together with all other disc tumbler locks using D8785 key blank. Available keyed different (**KD**) or keyed alike (**KA**).

KEY BLANK—D8785.

PACKAGING—Supplied with two keys and mounting screws(NL-C8706 furnished with strike).

FINISHES—**3**-Bright Brass, **4G**-Antique Brass, **14A**- Bright Nickel.

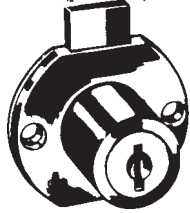
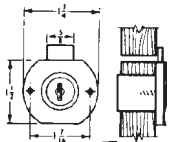

NL-C8703
NL-C8705

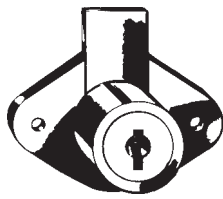
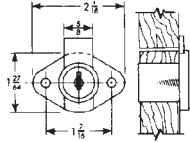

NL-C8803

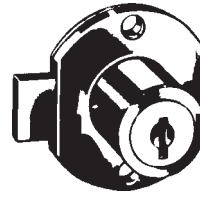
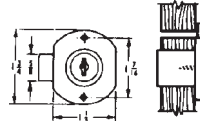

NL-C8704

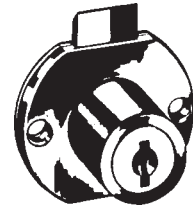
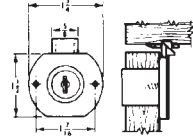

NL-C8706

Stock #	Installation	Bolt Type	Cylinder Length	Bolt Travel	Keyed Alike Numbers Available
NL-C8703-3	Drawer	Dead	15/16"	11/32"	C346A, C413A, C415A, C420A, C642A
NL-C8703-4G	Drawer	Dead	15/16"	11/32"	C346A, C642A
NL-C8703-14A	Drawer	Dead	15/16"	11/32"	C346A, C415A, C420A, C642A
NL-C8704-3	Door	Dead	15/16"	11/32"	C413A, C415A, C642A
NL-C8704-4G	Door	Dead	15/16"	11/32"	C642A
NL-C8704-14A	Door	Dead	15/16"	11/32"	C415A, C642A
NL-C8705-3	Drawer	Dead	1-3/16"	11/32"	C413A, C415A
NL-C8705-4G	Drawer	Dead	1-3/16"	11/32"	C413A, C415A
NL-C8705-14A	Drawer	Dead	1-3/16"	11/32"	
NL-C8706-3	Drawer	Spring	15/16"	9/32"	C413A, C415A
NL-C8803-3	Drawer	Dead	15/16"	11/32"	C346A, C390A, C413A, C415A
NL-C8803-4G	Drawer	Dead	15/16"	11/32"	
NL-C8803-14A	Drawer	Dead	15/16"	11/32"	C415A, C420A

Available **KD**-Keyed Different or **KA**-Keyed Alike. **Specify KD or KA**

CHEST, CUPBOARD & DRAWER LOCKS

Also be sure to check "DESK LOCKS" on pages 291-292 if you cannot find it here.

FURNITURE LOCKS

CompX
NATIONAL

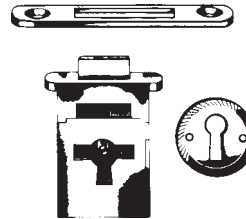
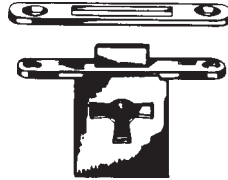
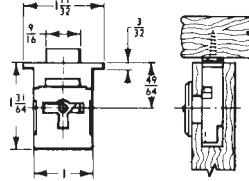
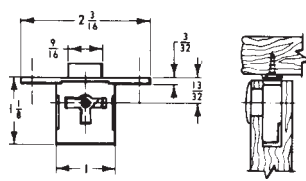

NL-C8252-3
NL-C8253-3

NL-C8207-3

APPLICATION—This group of locks is used primarily on furniture and other fine cabinetry. Additional mortising required for lock selvage plus hole for key entry.

OPERATION—Key removable in both locked and unlocked positions.

KEYING—Each lock furnished **keyed alike**.

KEY BLANK—D8890.

PACKAGING—Supplied with one key. All locks except NL-C8826 are supplied with strikes. Key hole escutcheons are packed with NL-C8207.

FINISHES—3-Bright Brass.

Stock No.	Installation	Bolt Type	Bolt Travel
NL-C8207-3	R.H. Door, Drawer	Dead	3/16"
NL-C8252-3	Full Mortise	Dead	3/16"
NL-C8253-3	L.H. Door, Full Mortise	Dead	3/16"

CHEST/LID LOCKS

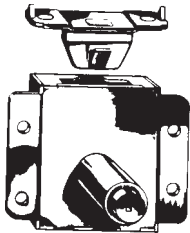
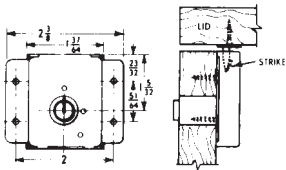

NL-C8412-4G

APPLICATION—Lid locks for cedar chest application and other lid locking requirements. NL-C8414 is surface mounted and requires a 9/16" dia. hole for cylinder.

OPERATION—Key removable in both locked and unlocked positions. NL-C8414 has a safety feature requiring operation of pushbutton to lock or latch lid closed.

KEYING—Each lock furnished **keyed alike**.

KEY BLANK—D8191 for NL-C8412.

PACKAGING—Supplied with one key. Appropriate strikes and mounting screws supplied with locks.

FINISHES—3-Bright Brass, 4G-Antique Brass.

Stock #	Installation	Bolt Type	Cylinder Length	Bolt Travel
NL-C8412-4G	Chest lid, Surface Mounted	Internal Engages Strike	7/8"	—

©ZIPF LOCK COMPANY

SUPER SPECIAL PRICING AVAILABLE ON ITEMS MARKED WITH ■ - SUPPLIES LIMITED - PLEASE INQUIRE.

265_{v1}
(PL-20)

CHEST, CUPBOARD & DRAWER LOCKS

Also be sure to check "DESK LOCKS" on pages 291-292 if you cannot find it here.



All Timberline Locks consist of two separate components: a lock plug and a cylinder body. A change tool (TB-D500KY) is required to remove lock plugs from the cylinder bodies.

REMOVABLE LOCK PLUG SYSTEM

- Wide selection of locks to fit most furniture & cabinet applications.
- Available in several high quality finishes.
- Removable lock plugs for complete keying versatility.
- Prepackaged in poly-bags for easy distribution to your customer.

These lock plugs will fit in **ALL Timberline Locks**

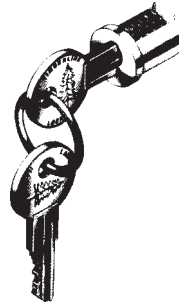

Stock No.	Finish
TB-C100LP-14A	Polished Nickel
TB-C200LP-8	Old English
TB-C300LP-19	Black
TB-C400LP-20	Statuary Bronze
TB-C500LP3	Polished Brass
Available Keyed Different (KD) or Keyed Alike (KA): 100T or 105T	

DOOR LOCKS

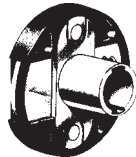

TB-C240CB

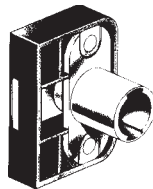

TB-C290CB

APPLICATION—Surface mounted lock for locking doors.
OPERATION—180° key rotation, CCW to lock, key removable in both locked and unlocked positions.
KEYING—Order lock plug separately. (See above)
PACKAGING—Housing is black, toughened nylon. Cylinder is unplated. Cams are zinc plated.

Stock No.	Cam Setback	Cam Extension*	Cam Throw
TB-C240CB	3/32"	15/16"	1/2"
TB-C290CB	9/32"	13/16"	3/8"

*Measured from center of cylinder to tip of cam in unlocked position.

DRAWER LOCKS

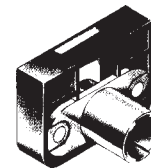

TB-C280CB

APPLICATION—Surface mounted lock for locking drawers.
OPERATION—180° key rotation, CCW to lock, key removable in both locked and unlocked positions.
KEYING—Order lock plug separately. (See above)
PACKAGING—Housing is black, toughened nylon. Cylinder is unplated. Cams are zinc plated.

Stock No.	Cam Setback	Cam Extension*	Cam Throw
TB-C280CB	9/32"	13/16"	3/8"

*Measured from center of cylinder to tip of cam in unlocked position.

CAM LOCK KIT—TB-C165CB

APPLICATION—Universal type lock for either doors or drawers. Kit contains a variety of easily switched cams to accommodate most locking situations.
OPERATION—90° key rotation, CCW to lock.
KEYING—Order lock plug separately. (See above)
PACKAGING—Cylinder supplied with two straight cams and two bent cams. Cylinder is unplated. Cams are zinc plated.

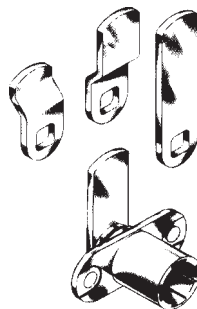

Stock No.	Description
TB-C165CB	Cam Lock Kit

This kit will replace the following Timberline cam locks:

90° Rotation		180° Rotation	
CB-080	CB-090	CB-180	CB-190
CB-083	CB-093	CB-183	CB-193
CB-084	CB-094	CB-184	CB-194
CB-085	CB-095	CB-185	CB-195
CB-087	CB-097	CB-187	CB-197
CB-088	CB-098	CB-188	CB-198

Need a lock not shown here?? Then just give us a call 1-800-848-1577.

CHEST, CUPBOARD & DRAWER LOCKS

Also be sure to check "DESK LOCKS" on pages 291-292 if you cannot find it here.

TWO DRAWER SIDE GANG LOCK—TB-D270CB

APPLICATION—Two drawer gang lock for locking two pedestal drawers with a single lock. Lock mounts on side of cabinet.

OPERATION—180° key rotation, CCW to lock. Key removable in both locked and unlocked position.

KEYING—Order lock plug separately. (See previous page)

PACKAGING—Housing supplied with two C500DC-19 Drawer Clips. Housing is black, toughened nylon. Cylinder is unplated. Cams are zinc plated.

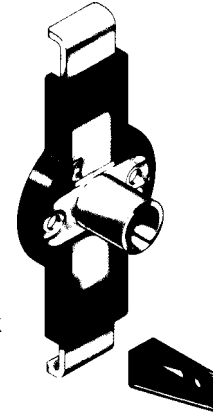

Stock No. TB-D270CB	Description Side Gang Lock
-------------------------------	--------------------------------------

DOUBLE DOOR LOCKS

APPLICATION—Surface mount lock for locking two adjacent doors. Eliminates the need for a spring catch on the door opposite the lock. Works with either overlay or inset doors.

OPERATION—180° key rotation, CCW to lock. Key removable in both locked and unlocked position.

KEYING—Order lock plug separately. (See previous page)

PACKAGING—Supplied with two strike plates as shown. Housing is black, toughened nylon. Cylinder is unplated. Cams are zinc plated.

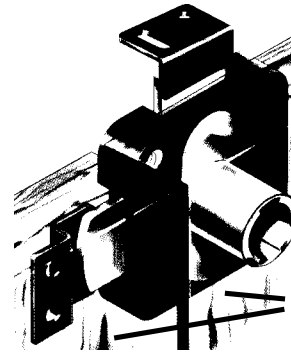

Stock No. TB-C250CB	Description Double Door Lock
-------------------------------	--

Top Cam Setback: 3/16"
 Top Cam Extension*: 29/32"
 Side Cam Setback: 3/32"
 Side Cam Extension*: 29/32"
 Cam Throw: 1/2"

*Measured from center of cylinder to tip of cam in unlocked position.

Locks both doors without the use of a spring catch.

THICK PANEL LOCK

APPLICATION—Universal type lock for either doors or drawers that can accommodate panel thickness from 7/8" to 1-3/8" thick.

OPERATION—90° key rotation, CCW to lock.

KEYING—Order lock plug separately. (See previous page)

PACKAGING—Housing supplied with straight cam and bent cam. Housings are unplated. Cams are zinc plated.

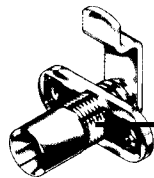

Stock No. TB-C170CB	Description Thick Panel Lock
-------------------------------	--

Mounting flange adjust to allow lock to be mounted in panels from 7/8" thick up to 1-3/8" thick.

TOOLS



TB-D500KY
CHANGE TOOL
 This tool required to remove lock plugs from cylinder bodies.

KEY BLANK

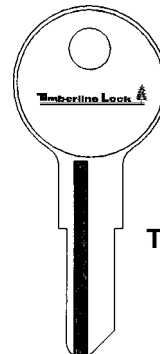

TB-D300KY

©ZIPF LOCK COMPANY

SUPER SPECIAL PRICING AVAILABLE ON ITEMS MARKED WITH ■ - SUPPLIES LIMITED - PLEASE INQUIRE.

267_{v3}
 (PL-20)

CHEST, CUPBOARD & DRAWER LOCKS

Also be sure to check "DESK LOCKS" on pages 291-292 if you cannot find it here.

GANG LOCK CYLINDER BODY

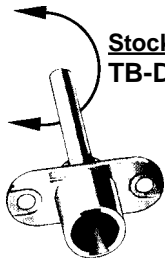

Stock No.
TB-D100CB

Description
For Front Mount Systems

See previous page
for lock plugs.

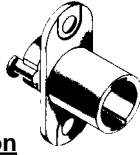

Stock No.
TB-D150CB

Description
For Side Mount Systems

CompX
TIMBERLINE

BEZELS

- Allows cylinder bodies to be used with 3/4" through 7/8" diameter holes and permits use of locks in 7/8" thick panels.



Stock No.
TB-C100BZ-14A
TB-C200BZ-8
TB-C300BZ-19
TB-C400BZ-20
TB-C500BZ-3

Finish
Bezel Nickel
Bezel Old English
Bezel Black
Bezel Statuary Bronze
Bezel Brass

STRIKE PLATES



TB-C185SP-19

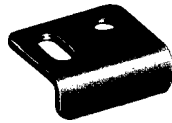

TB-C100SP-19

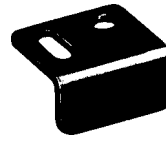

TB-C101SP-19

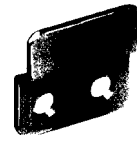

TB-C257SP-19

T37 T-BOLT DRAWER LOCK - SMALL PIN NATIONAL KEYWAY

GENERAL FEATURES—

Rekeyable: Working top-slide, patented "cylinder retainer staple" and removable bezel ring make rekeying fast and easy. No more need to pry off faceplates and pin retainer clips.

Retrofits: National C8137

Material: Zinc die cast lock body Bolt: Stainless steel

Includes: Brass mounting nut

Barrel diameter: 3/4" Across flats: 5/8"

Cylinder length: 19/32" For material: 1/4"

Finish: 26D

KEYING INFORMATION—

Keyway: National D4291 (4-pin) keyway

Stock KA#: 915. Other KA# by special order.

OLYMPUS
LOCK, INC.



Stock No.
OS-T37-26D-KD
OS-T37-26D-KA915

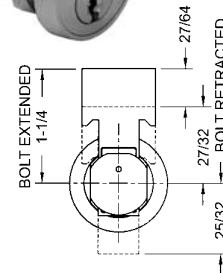
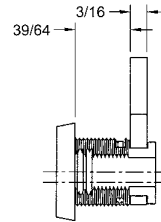
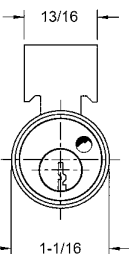
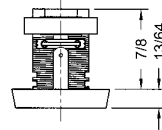

998 LATCH LOCK - SMALL PIN NATIONAL KEYWAY

GENERAL FEATURES—

Rekeyable: Easily rekeyable via set screw cylinder release mechanism.

Reversible: Easily reversible between door and drawer function.

4 locks in one. You can rotate the cylinder housing for the following hands: left hand, right hand, vertical hand, inverted hand.

Material: Zinc die cast lock body

Includes: Matching latch strike

Barrel diameter: 7/8" Cylinder length: 15/16"

Finish: 26D

KEYING INFORMATION—

Keyway: National D4291 (4-pin) keyway

Stock KA#: 915. Other KA# by special order.

OLYMPUS
LOCK, INC.

Stock No.
OS-998V-26D78-KD
OS-998V-26D78-KA915

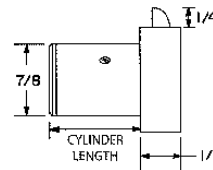
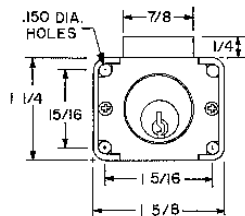

CHEST, CUPBOARD & DRAWER LOCKS

Also be sure to check "DESK LOCKS" on pages 291-292 if you cannot find it here.

100 / 200 DEADBOLT LOCK - SMALL PIN NATIONAL KEYWAY



GENERAL FEATURES—

Rekeyable: Easily rekeyable via set screw cylinder release mechanism
Certifications: Tested to ANSI/BHMA A156.11 Grade 1 cycle testing.
 Withstood in excess of 40,000 cycles with no damage. All other requirements of ANSI/BHMA A 156.11, no less than Grade 2 performance was attained.
Body: Zinc die cast lock body **Cylinder:** Solid brass pin tumbler cylinder
Barrel diameter: 7/8" **Includes:** 56-1 bar strike
Finish: 26D. *Other finishes by special order.*

KEYING INFORMATION—

Keyway: National D4291 (4 pin)
Stock keying: KD/KA - 4 pin standard
Stock KA#: 915. *Other KA# by special order.*

Stock No.
 •Door Lock: 15/16"
OS-100-26D78-KD
OS-100-26D78-KA915

Stock No.
 •Drawer Lock: 15/16"
OS-200-26D78-KD
OS-200-26D78-KA915
 •Drawer Lock: 1-3/8"
OS-200-26D138-KD
OS-200-26D138-KA915

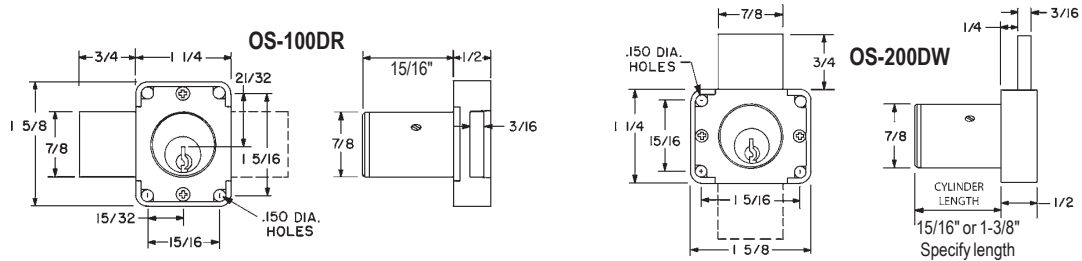

300 PLUNGER LOCK - SMALL PIN NATIONAL KEYWAY



GENERAL FEATURES—

Rekeyable: Easily rekeyable via speedrelease cylinder release mechanism
Body: Zinc die cast lock body
Cylinder: Solid brass pin tumbler cylinder
Barrel length: 1" **Barrel diameter:** 1"
Finish: 26D. *Other finishes by special order.*

KEYING INFORMATION—

Keyway: National D4291 (4 pin)
Stock keying: KD/KA - 4 pin standard
Stock KA#: 915. *Other KA# by special order.*

Includes: 10-24 machine thread bolt extender for varying gaps between bypassing doors. 10-24 machine thread strike locator. Matching thimble strike.

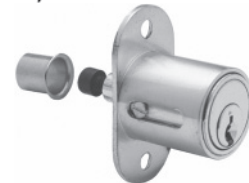
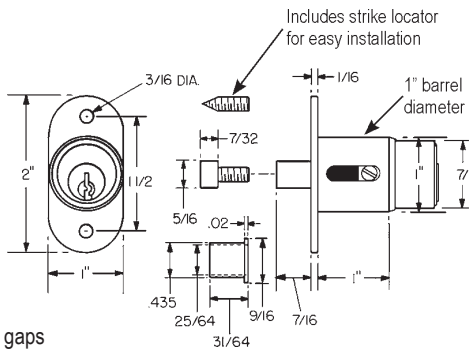

Stock No.
OS-300SD-26D-KD
OS-300SD-26D-KA915

722 PLUNGER LOCK - IC CORE - SMALL FORMAT



GENERAL FEATURES—

Barrel length: 1-3/4"
Bolt throw: 1/2"
Retrofits: Best 2S, 2S-TBM
Max. door thickness: 1-7/8" **Min. door thickness (TBM):** 5/8"
Finish: US26

Body: Zinc die cast lock body

KEYING INFORMATION—

Cores: Not included. *Order seperately.*
Accepts: Best, Arrow, Falcon, KSP, Schlage SFIC or equivalent small format interchangeable cores
Includes: Matching strike, plastic actuator. TBM also includes through bolts plates and screws

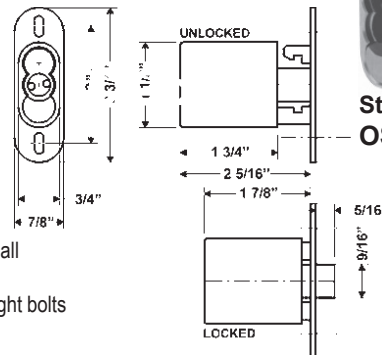

Stock No.
OS-722S-26D

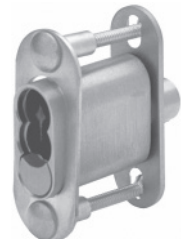

Stock No.
OS-722S-26D-TBM



CHEST, CUPBOARD & DRAWER LOCKS

Also be sure to check "DESK LOCKS" on pages 291-292 if you cannot find it here.

700S / 800S DEADBOLT LOCKS STANDARD CYLINDER-SCHLAGE STYLE

GENERAL FEATURES—

- Rekeyable:** Easily rekeyable via set screw cylinder release mechanism
 - Certifications:** Passed ANSI/BHMA A156.11 grade 1 cycle testing, obtained grade 2 performance for all other requirements
 - Body:** Zinc die cast lock body
 - Cylinder:** Will accept other manufacturer's Schlage compatible key-in-knob cylinders
 - Barrel lengths:** 7/8" to 1-1/8" adjustable
 - Barrel diameter:** 1-1/8"
 - Finish:** 26D. *Other finishes by special order.*
- ### KEYING INFORMATION—
- Keyway:** Schlage C keyway
 - Cylinder:** Solid brass pin tumbler cylinder
 - Stock keying:** KD/KA - 5 pin standard
 - Stock KA#:** 101. *Other KA# by special order.*

OLYMPUS
LOCK, INC.

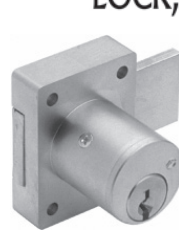

Stock No.
OS-700S-26D-KD
OS-700S-26D-KA101



Stock No.
OS-800S-26D-KD
OS-800S-26D-KA101



Includes:
1/4" plastic bar strike, 1/2" plastic bar strike, 2 plastic spacers (1/8" ea)

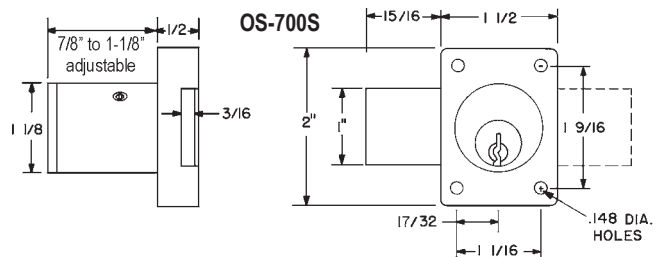
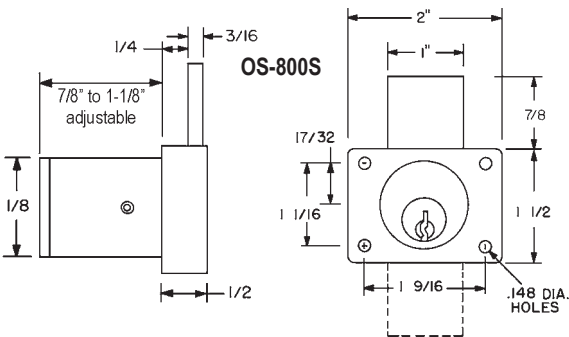

721 DEADBOLT LOCK IC CORE-SMALL FORMAT

GENERAL FEATURES—

- Reversible:** Field reversible between door and drawer functions
 - Certifications:** Passed ANSI/BHMA A156.11 Grade 1 performance requirements
 - Barrel length:** 7/8" to 1-1/4"
 - Barrel diameter:** 1-1/8"
 - Retrofits:** Best 3L
 - Body:** Zinc die cast lock body
 - Finish:** US26. *Other finishes by special order.*
- ### KEYING INFORMATION—
- Cores:** Not included. *Order separately.*
 - Accepts:** Best, Arrow, Falcon, KSP, Schlage SFIC or equivalent small format interchangeable cores

OLYMPUS
LOCK, INC.

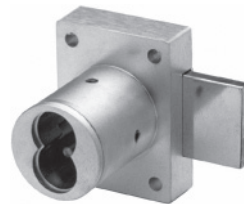

Stock No.
OS-721DR-26D

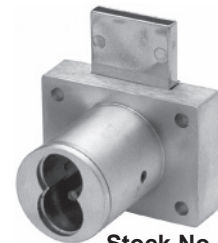

Stock No.
OS-721DW-26D

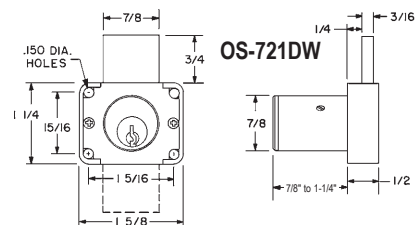
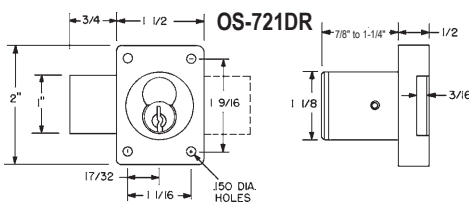
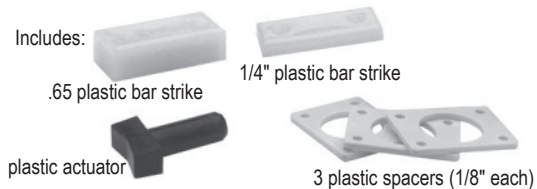

©ZIPF LOCK COMPANY

CHEST, CUPBOARD & DRAWER LOCKS

Also be sure to check "DESK LOCKS" on pages 291-292 if you cannot find it here.

725RD - RIM DEADBOLT (SURFACE) IC CORE - SMALL FORMAT

GENERAL FEATURES—

Mounting: Rim (surface)

Retrofits: Best 5L series cabinet lock

Certifications: Passed ANSI/BHMA A156.11 Grade 1 performance requirements

Material: Zinc die cast cylinder housing, steel back plate and steel case

Barrel length: 1-1/16"

Barrel diameter: 1-1/8"

Finish: US26. *Other finishes by special order.*

KEYING INFORMATION—

Cores: Not included. *Order seperately.*

Accepts: Best, Arrow, Falcon, KSP, Schlage SFIC or equivalent small format interchangeable cores

OLYMPUS
LOCK, INC.



Stock No.
OS-725RD-DW-VH-26D

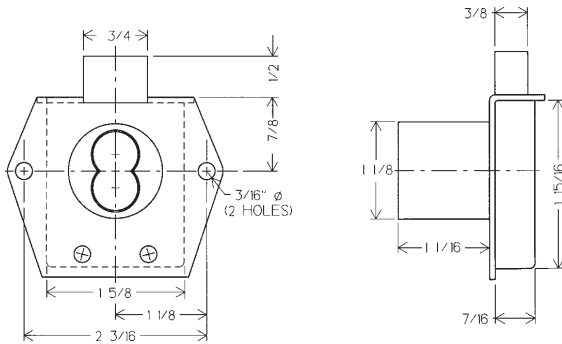

Includes:

spacer for
6 pin cores

plastic actuator

strike

725RL - RIM LATCH (SURFACE) IC CORE - SMALL FORMAT

GENERAL FEATURES—

Mounting: Rim (surface)

Latch: for out-swinging door applications.

Retrofits: Best 5L series cabinet lock

Certifications: Passed ANSI/BHMA A156.11 Grade 1 performance requirements

Material: Zinc die cast cylinder housing, steel back plate and steel case

Barrel length: 1-1/16"

Barrel diameter: 1-1/8"

Finish: US26. *Other finishes by special order.*

KEYING INFORMATION—

Cores: Not included. *Order seperately.*

Accepts: Best, Arrow, Falcon, KSP, Schlage SFIC or equivalent small format interchangeable cores

OLYMPUS
LOCK, INC.



Stock No.
OS-725RL-DW-VH-26D

Includes:

spacer for
6 pin cores

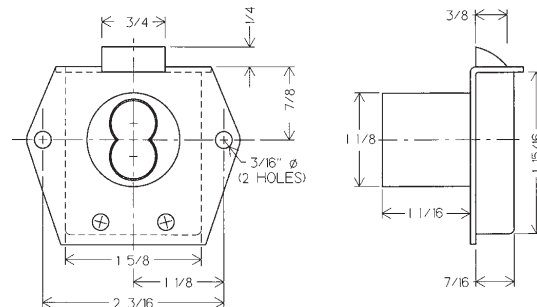

plastic actuator

strike

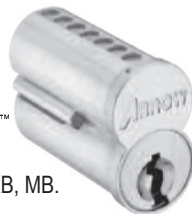

SMALL FORMAT CORES

Stock No. **Length**
AR-100CR-UC 6 pin
AR-7100CR-UC 7 pin



Keyways: 1D, AB, BB, DB, EB, FB, GB, HB, JB, KB, MB.

Finishes: 4-Satin Brass, 26D-Satin Chrome

To Order, Specify:

Stock No. Keyway and Finish (AR-C6S-UC AB 26D)

**REMEMBER: If you don't see what you need,
please contact us with your requirements.**

©ZIPF LOCK COMPANY