

CORBIN/RUSSWIN

HEAVY DUTY KNOB CK4200 SERIES

FEATURES:

- ANSI A156.2 Series 4000, Grade 1
- U.L. Listed
- Reversible

SPECIFICATIONS

| | |
|------------------------|---|
| DOOR THICKNESS: | 1-3/4" to 2" |
| BACKSET: | 2-3/4" square face |
| STRIKES: | ASA |
| BORE: | 2-1/8" |
| ROSE: | 2-7/8" |
| KEYWAYS: | D1, L4 or 981 |
| FINISHES: | 612 Satin Bronze 613 Dark Oxidized Satin Bronze, Oil Rubbed 626 Satin Chromium Plated |

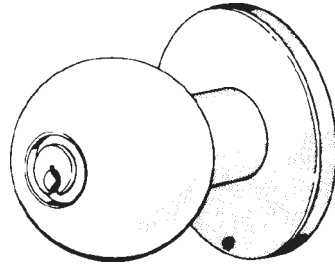

**GLOBAL
(GRC)**
613, 626

**Corbin
Russwin** 

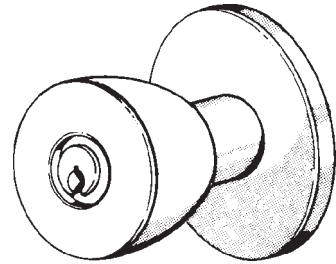

**BELMONT
(BRC)**
612, 626

Call for GREAT closeout prices.

| <u>Function</u> | | <u>Operation</u> |
|-----------------|-----------------|--|
| PASSAGE | \$CK4210 | Latchbolt by knob either side. Both knobs always free. (ANSI F75) |
| PRIVACY | \$CK4220 | Latchbolt by knob either side. Outside knob locked by push button. Outside knob unlocked by emergency release tool outside, by rotating inside knob or by closing door. Inside knob always free. (ANSI F76) |
| ENTRANCE | \$CK4251 | Deadlocking latchbolt by knob either side, except when turn button locks outside knob. Key outside retracts latchbolt. Outside knob unlocked by turn button. Inside knob always free. (ANSI F81) |
| CLASSROOM | \$CK4255 | Deadlocking latchbolt by knob either side, except when key outside locks outside knob. When outside knob is locked, latchbolt operated by key outside or by rotating inside knob. Inside knob always free. (ANSI F84) |
| STOREROOM | \$CK4257 | Deadlocking latchbolt by key in outside knob or by rotating inside knob. Outside knob always rigid. Inside knob always free. (ANSI F86) |

HOW TO ORDER: Specify,

| | | |
|-----------|------------------|---------------|
| Function: | RE-CK4251 | Entrance |
| Design: | GRC | Global Design |
| Finish: | 626 | Satin Chrome |
| Keyway: | D1 | D1 keyway |

TUBULAR DEADLOCKS DL2000 SERIES

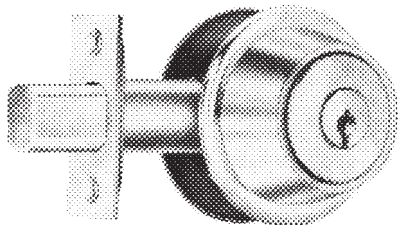

| | |
|-----------------|-----------------|
| \$DL2013 | Single Cylinder |
| \$DL2012 | Double Cylinder |

Call for GREAT closeout prices.

| | |
|------------------------|---|
| DOOR THICKNESS: | 1-3/4" to 2" |
| BACKSET: | Adjustable for 2-3/8" or 2-3/4" |
| BORE: | 2-1/8" |
| BOLT THROW: | 1" |
| KEYWAYS: | D1, L4 |
| FINISH: | 605 Bright Brass 626 Satin Chromium Plated |

©ZIPF LOCK COMPANY

CORBIN/RUSSWIN

STANDARD DUTY KNOB CK4400 SERIES

FEATURES:

- ANSI A156.2 Series 4000, Grade 2;
- U.L. Listed
- Reversible

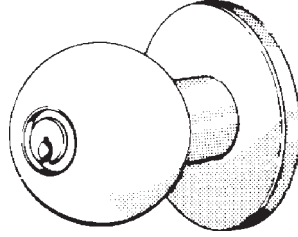

**GLOBAL
(GWC)**
613, 630

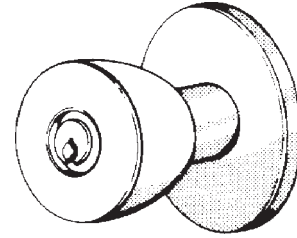

**BELMONT
(BWC)**
605, 612, 630

SPECIFICATIONS

DOOR THICKNESS: 1-1/4" to 1-3/4"
BACKSET: 2-3/4" square face
STRIKES: Global—ASA
 Belmont—"T" type
BORE: 2-1/8" x 1"
ROSE: 3"
KEYWAYS: D1, L1 or 981
FINISHES: **605** Bright Brass
612 Satin Bronze
613 Dark Oxidized Satin Bronze,
 oil rubbed
630 Satin Stainless Steel

*Call for GREAT
closeout prices.*

HOW TO ORDER: Specify,

| | | |
|-----------|------------------|-----------------------|
| Function: | RE-CK4451 | Entrance |
| Design: | GWC | Global Design |
| Finish: | 630 | Satin Stainless Steel |
| Keyway: | D1 | D1 keyway |

Function

PASSAGE **\$CK4410**

Operation

Deadlocking latchbolt by knob either side. Both knobs always free. **(ANSI F75)**

PRIVACY **\$CK4430**

Deadlocking latchbolt by knob either side. Outside knob locked by push button. Outside knob unlocked by turning slotted button outside, by rotating inside knob, or by closing door. **(ANSI F76)**

ENTRANCE **\$CK4451**

Deadlocking latchbolt by either knob, except when turn button locks outside knob. Pushing turn button in locks outside knob, requiring use of key outside to unlock. Turning inside knob unlocks outside knob. Pushing in and turning button locks outside knob, requiring key at all times. Turning inside knob does not unlock outside knob until button is manually turned to unlocked position. Inside knob always free. **(ANSI F81)**

**We still stock:
CK4451 GWC 630 D1**

CLASSROOM **\$CK4455**

Deadlocking latchbolt by knob either side, except when key outside locks outside knob. When outside knob is locked, latchbolt is operated by key outside or by rotating inside knob. Inside knob always free. **(ANSI F84)**

STOREROOM **\$CK4457**

Deadlocking latchbolt by key in outside knob, or by rotating inside knob. Outside knob always rigid. Inside knob always free. **(ANSI F86)**

CYLINDRICAL DEADLOCKS DL3000 SERIES

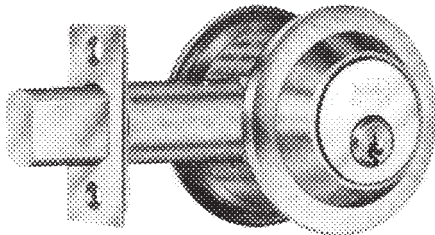

\$DL3011 Single Cylinder (Key outside/blank plate inside)
\$DL3012 Double Cylinder

DOOR THICKNESS: 1-3/4"
BACKSET: 2-3/4"
BORE: 2-1/8"
BOLT THROW: 1"
CYLINDER: Mortise
KEYWAYS: D1, L4
FINISH: **613** Dark Oxidized Satin Bronze, Oil Rubbed
626 Satin Chromium Plated

Call for GREAT closeout prices.

HOW TO ORDER: Specify,

| | | |
|-----------|------------------|-----------------------|
| Function: | RE-DL3013 | Single Cylinder |
| Finish: | 626 | Satin Chromium Plated |
| Keyway: | D1 | D1 keyway |

©ZIPP LOCK COMPANY

NOTE: Many Corbin-Russwin locks are being phased out. We also have Schlage with Corbin-Russwin keyways.

**141 v1
(PL-5)**

CORBIN/RUSSWIN

HEAVY DUTY LEVER CL3500 SERIES (3600)

FEATURES:

- ANSI A156.2 Series 4000, Grade 1
- U.L. Listed
- Non-handed
- Solid cast levers
- Independent return springs to prevent lever sag
- Throughbolted cylindrical chassis

SPECIFICATIONS

DOOR THICKNESS: 1-3/8" to 2"
BACKSET: 2-3/4" square face
STRIKE: ASA
BORE: 2-1/8"
ROSE: 3-1/2"
KEYWAYS: D1, L4
FINISHES: **626** Satin Chromium Plated

Complies with codes requiring lever to return to within 1/2" of door face.



Throughbolts prevent chassis rotation; ensure proper alignment, smooth operation and long life.

Solid cast levers without plastic inserts.



**NEWPORT
(NZD)
626**

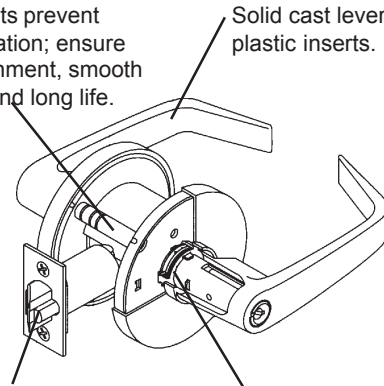

1/2" throw latchbolt accommodates 7/8" and 1" edge bore preps.

Non-handed spring cassette prevents lever sag.

Function
ENTRANCE

CL3551
(CL3651)

Operation

Deadlocking latchbolt by lever either side, except when turn button locks outside lever. Pushing turn button in locks outside lever, requiring use of key outside to unlock. Turning inside lever unlocks outside lever. Pushing in and turning button locks outside lever, requiring key at all times. Turning inside lever does not unlock outside lever until button is manually turned to unlocked position. Inside lever always free. (ANSIF81/82)

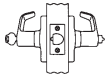

HOW TO ORDER: Specify,

| | | |
|-----------|------------------|-----------------------|
| Function: | RE-CL3551 | Entrance |
| Design: | NZD | Newport Design |
| Finish: | 626 | Satin Chromium Plated |
| Keyway: | D1 | D1 keyway |

LATCHES

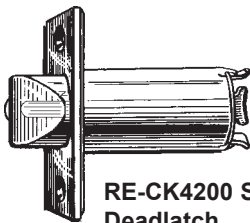

**RE-CK4200 Series
Deadlatch**

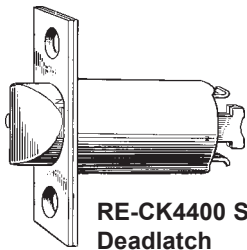

**RE-CK4400 Series
Deadlatch**

| <i>RUSSWIN</i> | 2-3/8" Square Face | 2-3/4" Square Face |
|------------------------------|------------------------|------------------------|
| CK4200 Series Deadlatch | | ZL-111 (486F89) |
| CK4430 Latch | ZL-422 (574F30) | ZL-423 (574F56) |
| CK4410, 51, 55, 57 Deadlatch | ZL-424 (574F29) | ZL-425 (574F55) |

CORBIN/RUSSWIN

MORTISE LOCKSETS ML2200SERIES

FEATURES:

- ANSI A156.13 Series 1000, Grade 1
- U.L. Listed
- Handed, field reversible

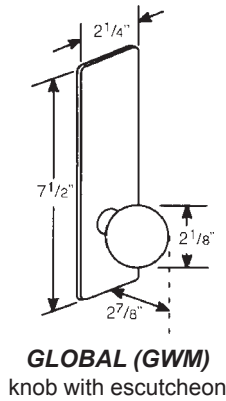
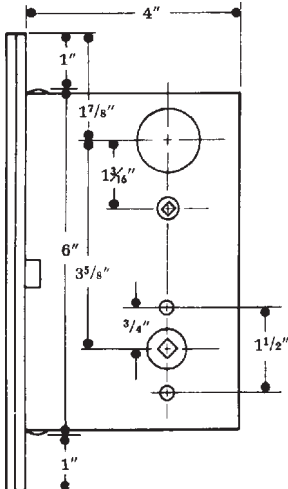

GLOBAL (GWM)
knob with escutcheon

DOOR THICKNESS: 1-3/4"
BACKSET: 2-3/4"
CASE: Heavy gauge chrome plated steel
 5-7/8" x 4" x 15/16"
FRONT: Heavy gauge steel, 8" x 1-1/4" x 3/32"
BOLT THROW: 1"
CYLINDER: Mortise
KEYWAYS: D1
FINISH: 612 Satin Bronze (Discontinued)
 626 Satin Chromium Plated

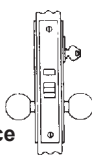
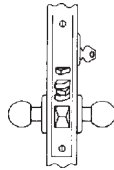
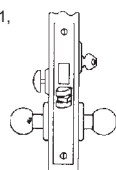
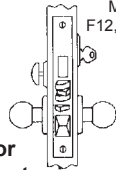
| | | |
|--|---|---|
| Classroom Doors | Meets ANSI F05, Grades 1, 2, 2L Fed Spec. 86J, 87J Call for closeout price \$ML2255  | Latch bolt by key outside and knob either side unless outside knob is locked by key outside. Inside knob always free. Deadlocking latch. |
| Entrance and Office Doors | Meets ANSI F04, Grades 1, 2, 2L Fed Spec. 86E, 87E ML2251 GWN 626  | Latch bolt by key outside and knob either side unless outside knob is locked by toggle-action stop. Auxiliary latch deadlocks latch bolt and prevents manipulation of locked toggle-action stop. |
| Dormitory, Entrance and Storeroom Doors | Meets ANSI F13, Grades 1, 2, 2L Call for closeout price \$ML2265  | Latch bolt by knob either side. Deadbolt by key outside and turnpiece inside. When deadbolt is projected, latchbolt is deadlocked and outside knob is locked. Turning inside knob retracts latch and deadbolt simultaneously, automatically unlocking outside knob. |
| Apartment and Dormitory Doors | Meets ANSI F12, Grades 1, 2, 2L Call for closeout price \$ML2267  | Latch bolt by knob either side EXCEPT WHEN outside knob is locked by stop or projecting deadbolt. Deadbolt by key outside and turnpiece inside. Inside knob retracts latch bolt and deadbolt. Deadlocking latch. |

HOW TO ORDER, Specify:

| | | | |
|-----------------|-------------|--------|--------|
| Function Number | Trim Design | Finish | Keyway |
| ML2251 | GWM | 626 | D1 |

CYLINDERS

1-1/8" MORTISE (6 pin)

1000-118- * - **

*Keyway Options: 6L4, 6D1, 852, 981

**Finishes: 605, 612, 613, 626

TO ORDER, Specify:

| | | |
|------------------|--------|--------|
| Cylinder No. | Keyway | Finish |
| 1000-100 | 5D1 | 626 |
| = | | |
| 1000-100-5D1-626 | | |

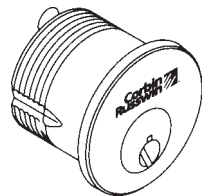

Call for closeout price

RIM CYLINDER (6 pin)

3000-200- * - **

*Keyway Options: 6L4, 6D1, 852, 981

**Finishes: 605, 626 (6L4 also 612, 613)

852 keyway available in 605 only

TO ORDER, Specify:

| | | |
|------------------|--------|--------|
| Cylinder No. | Keyway | Finish |
| 3000-200 | 6L4 | 626 |
| = | | |
| 3000-200-6L4-626 | | |

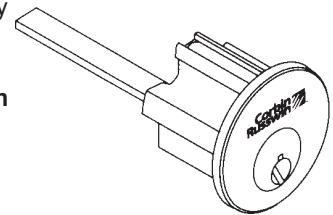

Call for closeout price

CYLINDER PLUGS

FOR RE-CK4200 SERIES (6 pin)

488K98- * - **

*Keyway Options: 59A1, 60, 6L4, 981

**Finishes: 605, 626

Call for closeout price

FOR RE-CK4400 SERIES (6 pin) not CK4429

574K05- * - **

*Keyway Options: 59A1, 60, 6D1, 6L4, 981

**Finishes: 605, 626

FOR RE-CL3400, 3600, 3800 SERIES (6 pin) not CL3429, CL3629.

585K24- * - **

*Keyway Options: 59A1, 60, 6L4, 981

**Finishes: 605, 626

NOTE: Many C-R cylinders are being phased out. We also have Ilco (Lori) with Corbin-Russwin keyways.

143 v1
(PL-5)

CORBIN/RUSSWIN

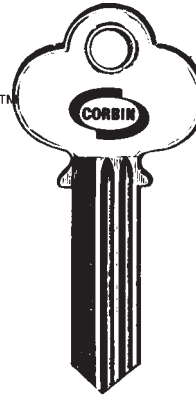

OLD BOW PHASE OUT
NEW NUMBER PHASE IN...



 27-5PIN-10B 5 pin
27-6PIN-10B 6 pin

 77-5PIN-10B 5 pin
77-6PIN-10B 6 pin

 97-5PIN-10B 5 pin
97-6PIN-10B 6 pin

 67-5PIN-10B 5 pin
 99-5PIN-10B 5 pin
67-6PIN-10B 6 pin

At the printing of this catalog Corbin/Russwin has renumbered their key blanks and phased in a new key blank bow (pictured above). Transition from old bow to new bow and old number to new numbers will continue until old supplies are depleted and replaced by new supplies. Therefore we can not guarantee which bow you will receive.

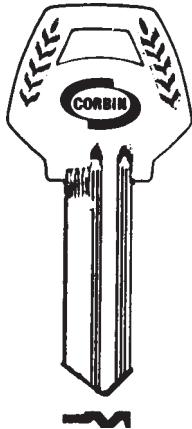

60-5PIN-10B 5 pin
60-6PIN-10B 6 pin

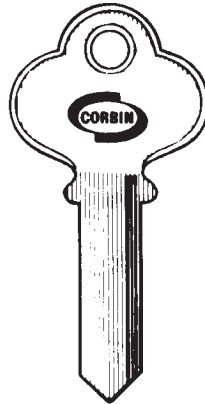

NOTE: Factory order only
Call for quote and new Corbin/
Russwin numbers

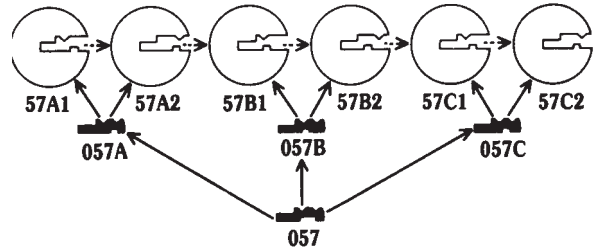

Plug sections are shown in circles. Key sections are shown shaded. All shaded sections are Master Key. Arrows indicate master key control.

10-Nickel Silver
10B-Brass

59A1-5PIN-10**
59A1-6PIN-10B

59B1-5PIN-10**
59B1-6PIN-10B

59C1-6PIN-10

59D1-6PIN-10

59A2-5PIN-10**
59A2-6PIN-10B

59B2-5PIN-10**
59B2-6PIN-10B

59C2-6PIN-10B*

59D2-6PIN-10

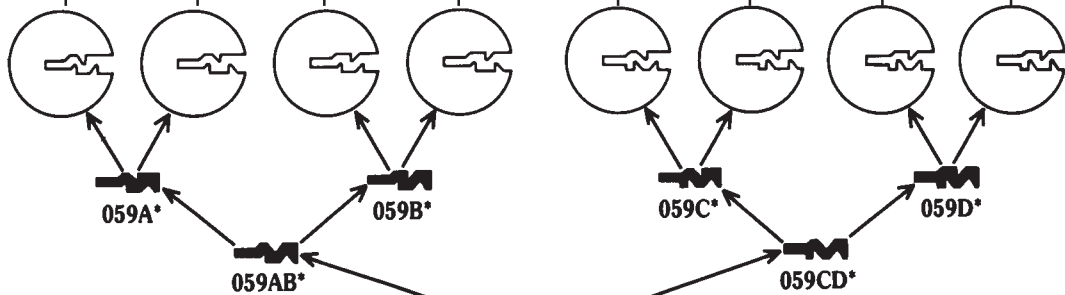
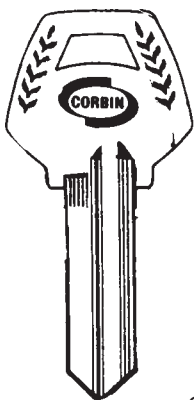

*NOTE: Factory order only
Call for quote and new Corbin/
Russwin numbers

Plug sections are shown in circles. Key sections are shown shaded. All shaded sections are Master Key. Arrows indicate master key control.

**There is a limited quantity in brass-suffix "B"

©ZIPP LOCK COMPANY

CORBIN/RUSSWIN

OLD BOW PHASE OUT
NEW NUMBER PHASE IN...



At the printing of this catalog Corbin/Russwin has renumbered their key blanks and phased in a new key blank bow (pictured above). Transition from old bow to new bow and old number to new numbers will continue until old supplies are depleted and replaced by new supplies. Therefore we can not guarantee which bow you will receive.

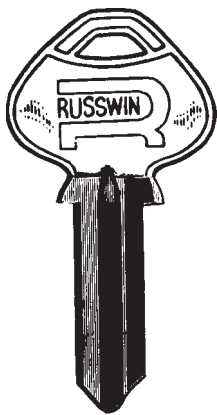
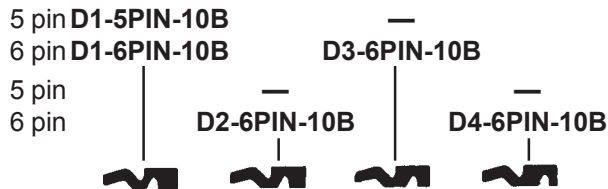

752-5PIN-10B

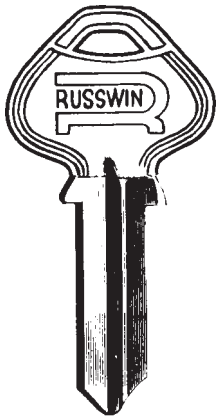

852-5PIN-10B

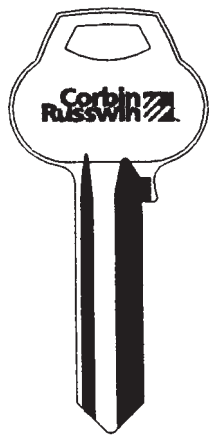
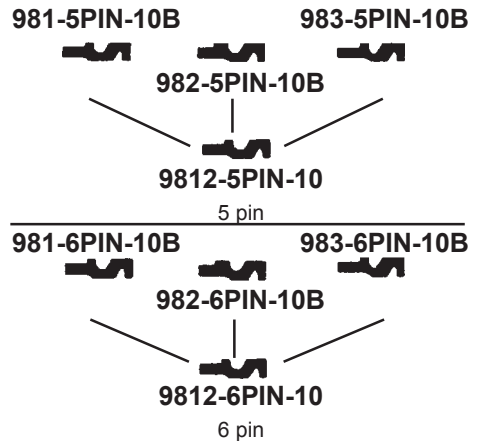
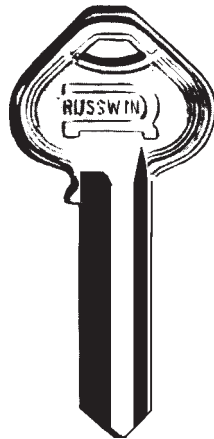

L4-6PIN-10

DOOR CLOSERS

DC6000 SERIES DOOR CLOSER



- UL/ULC/UL10c Listed
- ANSI A156.4, Grade 1
- 10 year warranty

One Size Fits All

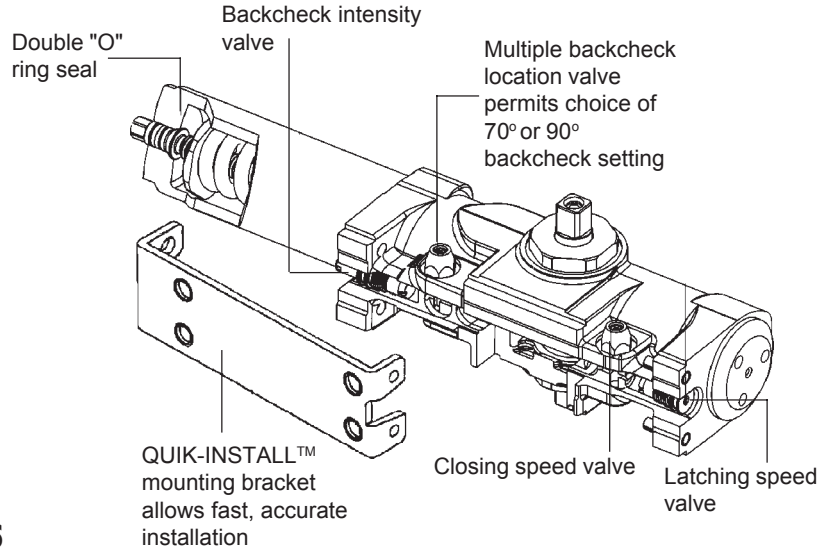
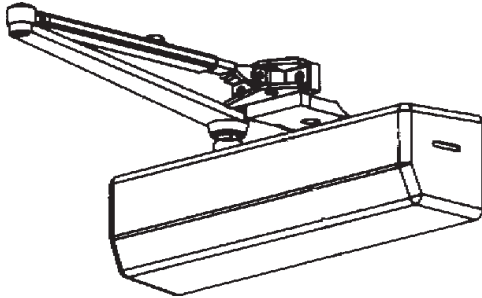

Corbin/Russwin DC6000 Series Multi-Sized Door Closers

Conditions vary from job to job, but a top-quality product that is dependable, easy to install and versatile is a must. The DC6000 Series door closer is the solution. A variety of features makes this the choice for retrofitting, quick installation, and longevity. The small footprint and unobtrusive cover are additional advantages to a versatile line of closers.

- **UL/ULC/UL10c:** Listed for fire and cycle requirements.
- **ANSI:** Meets A156.4, Grade 1, and A117.1 Accessibility Code.
- **Spring Power:** Multi-Sized, Fully adjustable 1 through 6.
- **Power Adjustment Arm Bracket:** 15% adjustment.
- **Fluids:** High lubricity extreme temperature hydraulic fluid.
- **Body:** Cast iron case w/seamless cold headed steel spring tube.
- **Degree of Opening:** Up to full 180 degree opening.
- **Handing:** Non-Handed.
- **Springs:** Chrome silicon wire.
- **Valves:** Latching and Closing speed valves. Multiple backcheck location and backcheck intensity valves
- **Cover:** Non-metallic full cover.
- **Mountings:** Regular, top jamb and parallel arm installations.
- **Warranty:** Ten-year limited.

Description:

Springs can be adjusted to provide a full range of closer sizes (1 thru 6). Closers can be adjusted, at the job site, to suit various door sizes and conditions.

Spring Adjustment: Installation form gives instructions for setting closer to accommodate various door sizes.

Stock No.
RE-DC6210

Type of Closer
Non-Hold Open

Finishes

- 689** Silver Aluminum Painted
- 690** Dark Bronze Painted

Applications:

Regular, Top Jamb and Parallel Arm (M100)

Includes:

Parallel Arm Bracket, Sex Nuts and bolts(M54)

| DOOR SIZE CHART | | | | |
|----------------------|----------|-------------------|--------------------|-------------------------|
| Type of Installation | Interior | Exterior In-swing | Exterior Out-swing | Recommended Closer Size |
| Regular & Top Jamb | 2'4" | — | — | 1 |
| | 3'0" | — | — | 2 |
| | 3'6" | 2'6" | 3'0" | 3 |
| | 4'0" | 3'0" | 3'6" | 4 |
| | 4'6" | 3'6" | 4'0" | 5 |
| Parallel Arm | 5'0" | 4'0" | 4'6" | 6 |
| | 2'4" | — | — | 1 |
| | 2'6" | — | — | 2 |
| | 3'0" | — | 2'6" | 3 |
| | 3'6" | — | 3'0" | 4 |
| | 4'0" | — | 3'6" | 5 |
| | 4'6" | — | 4'0" | 6 |

DOOR CLOSERS

DC3000 SERIES DOOR CLOSER



- UL and UL10C Listed
- ANSI A156.4, Grade 1
- 5 year warranty

One Size Fits All

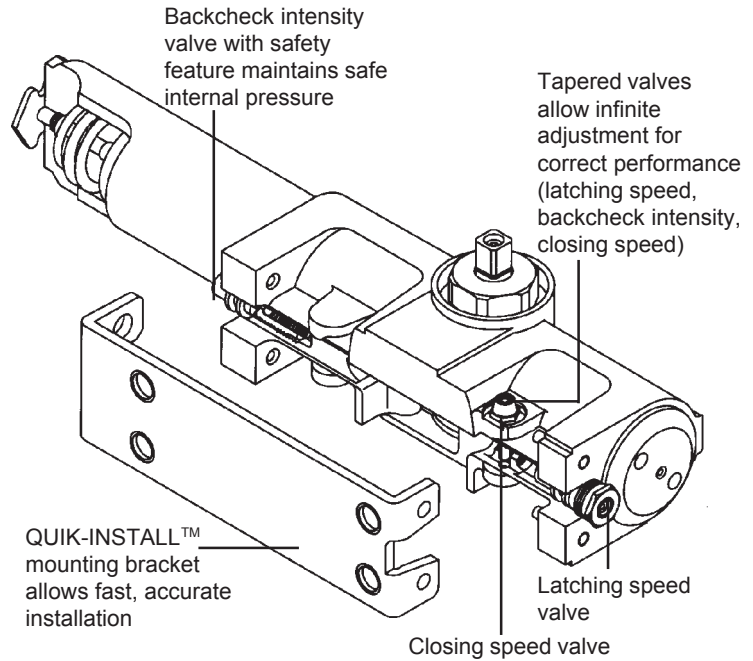
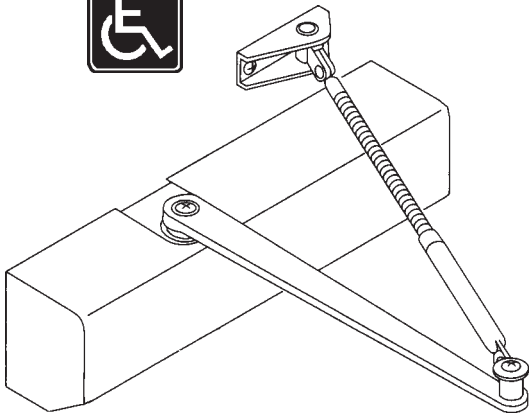

Corbin/Russwin DC3000 Series Multi-Sized Door Closers

• The mid-priced, cost effective choice for high-traffic situations. DC3000 Series Door Closers fulfill security and life safety requirements by ensuring reliable latching for access control and fire code compliance, along with ease of operation and precise adjustability for barrier-free code compliance. Ideal for virtually all door openings and draft conditions in both new construction and renovations.

- **UL & UL10C:** Listed for fire and cycle requirements.
- **ANSI:** Meets A156.4, Grade 1, and A117.1 Accessibility Code.
- **Spring Power:** Multi-Sized, Fully adjustable 1 through 6.
- **Power Adjustment Arm Bracket:** 15% adjustment.
- **Fluids:** High lubricity hydraulic fluid.
- **Body:** Cast iron case w/seamless one-piece forged steel spring tube.
- **Degree of Opening:** Up to full 180 degree opening.
- **Handing:** Non-Handed.
- **Springs:** Double heat treated steel and tempered.
- **Valves:** Latching and Closing speed valves. Backcheck intensity valve with safety feature.
- **Cover:** Non-metallic full cover.
- **Mountings:** Regular, top jamb and parallel arm installations.
- **Warranty:** Five-year limited.

Description:

Springs can be adjusted to provide a full range of closer sizes (1 thru 6). Closers can be adjusted, at the job site, to suit various door sizes and conditions.

Stock No. RE-DC3210
Type of Closer Non-Hold Open

Finishes
689 Silver Aluminum Painted
690 Dark Bronze Painted

Applications:
Regular, Top Jamb and Parallel Arm (M100)

Includes:
Parallel Arm Bracket, Sex Nuts and bolts(M54)

| DOOR SIZE CHART | | | | |
|----------------------|----------|-------------------|--------------------|-------------------------|
| Type of Installation | Interior | Exterior In-swing | Exterior Out-swing | Recommended Closer Size |
| Regular & Top Jamb | 2'4" | — | — | 1 |
| | 3'0" | — | — | 2 |
| | 3'6" | 2'6" | 3'0" | 3 |
| | 4'0" | 3'0" | 3'6" | 4 |
| | 4'6" | 3'6" | 4'0" | 5 |
| Parallel Arm | 5'0" | 4'0" | 4'6" | 6 |
| | 2'4" | — | — | 1 |
| | 2'6" | — | — | 2 |
| | 3'0" | — | 2'6" | 3 |
| | 3'6" | — | 3'0" | 4 |
| | 4'0" | — | 3'6" | 5 |
| | 4'6" | — | 4'0" | 6 |

Spring Adjustment: Installation form gives instructions for setting closer to accommodate various door sizes.

©ZIPF LOCK COMPANY

DOOR CLOSERS

DC4000 SERIES DOOR CLOSER



- UL and ULC Listed
- 2 year warranty

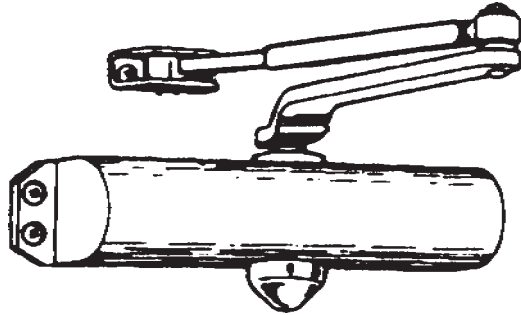

| Stock No. | Size | Old Number |
|-----------|------|------------|
| RE-DC4602 | 2 | (DC4612) |
| RE-DC4603 | 3 | (DC4613) |
| RE-DC4604 | 4 | (DC4614) |
| RE-DC4605 | 5 | (DC4615) |

Finishes

- 689 Silver Aluminum Painted
- 690 Dark Bronze Painted
- 691 Light Bronze Painted

Applications:

Regular, Top Jamb and Parallel Arm (M100)

Corbin/Russwin DC4000 Series Door Closers

• Proven Corbin Russwin quality in an economical door closer. Ease of use, reliable performance and fire code compliance make the DC4000 Series Door Closer ideal for such light duty applications as: Residences, Offices, Apartments, Hotels & Motels, Retail outlets and Warehouses.

- **UL & ULC:** Listed for closers with non-hold open arms.
- **Spring Power:** Sizes 2, 3, 4 and 5 available.
- **Power Adjustment Arm Bracket:** 15% (plus/minus 7-1/2%) adjustment.
- **Fluids:** High lubricity hydraulic fluid.
- **Body:** Cast aluminum.
- **Degree of Opening:** Up to full 180 degree opening.
- **Handing:** Non-Handed.
- **Springs:** Tempered steel.
- **Valves:** Closing speed valve, latch speed valve & backcheck valve.
- **Cover:** None.
- **Mountings:** Regular, top jamb and parallel arm installations.
- **Minimum Mounting Requirements:** Regular arm: 2-1/2" top rail, 1/8" reveal; Parallel Arm: 5" top rail without drop plate; Top jamb: 1-3/8" top rail, up to 2-7/8" reveal.
- **Warranty:** Two-year limited..

DOOR SIZE CHART

| Type of Installation | Interior | Exterior, Reg. Arm | Exterior, Top Jamb | Recommended Closer Size |
|----------------------|----------|--------------------|--------------------|-------------------------|
| Regular & Top Jamb | 3'0" | — | — | 2 |
| | 3'6" | 3'2" | 3'0" | 3 |
| | 4'0" | 3'8" | 3'6" | 4 |
| | 4'6" | 4'2" | 4'0" | 5 |
| Parallel Arm | 2'6" | — | — | 2 |
| | 3'0" | — | 2'6" | 3 |
| | 3'6" | — | 3'0" | 4 |
| | 4'0" | — | 3'6" | 5 |

POWER ADJUSTMENT ARM BRACKET:

Standard on all closers without hold-open. In regular arm or top jamb mounting, forearm may be relocated to adjust power plus or minus 7-1/2%.

This is a limited adjustment to increase or decrease holding power when door is in the closed position.

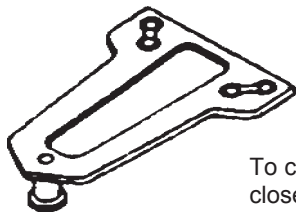
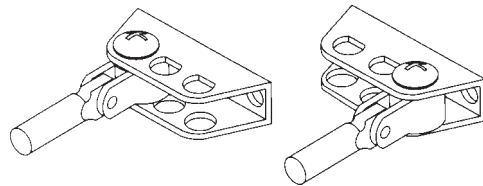

BRACKET FURNISHED WITH CLOSER

To convert regular arm closer to parallel arm closer

HOLLOW-CORE DOORS (SEX BOLTS-INCLUDED WITH CLOSERS)



- KW-1192** 1-3/4" door
- KW-1194** 1-3/8" door

•Set of 4 sex bolts for metal doors.

©ZIPF LOCK COMPANY

EXIT DEVICES



- ANSI A156.3, Type 1, Grade 1
- A117.1 Accessibility Code
- 3-year limited warranty

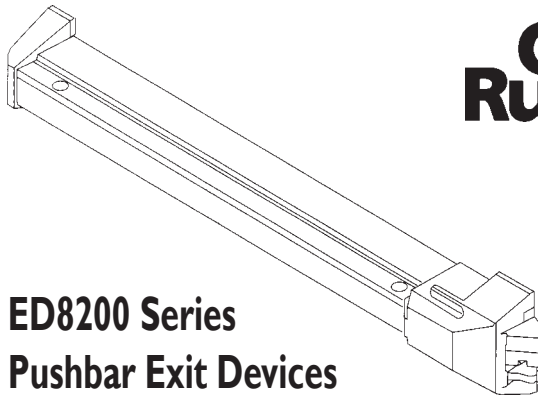

ED8200 Series Pushbar Exit Devices

- Heavy duty steel construction and Grade 1 performance, priced for outstanding value. Meets rigorous life safety and security requirements, while offering pleasing aesthetics and trouble-free operation. Designed for high-use, high-abuse situations, ED8000 Pushbar Exit Devices can be teamed with a variety of Corbin Russwin trims to provide desired functions, styles and finishes in new construction and renovations.
- **U.L.** listed for safety as panic hardware..
- **ANSI:** Meets A156.3, Type 1, Grade 1, and A117.1 Accessibility Code.
- **ADA:** Exit Devices, lever trims and pulls comply.
- **Handing:** Non-handed. ▪ **Fasteners:** Machine screws.
- **Bar Length:** Easily field cut to size. 36" bar fits 31" - 36" door; 42" bar fits 37" - 42" door.
- **Door Thickness:** 1-3/4". ▪ **Stile:** Minimum width 5".
- **Backset:** 2-3/4". Device and trim cover standard ANSI A115.2 (Type 161) cylindrical lock preparation.
- **Latchbolt:** 3/4" stainless steel pullman type with stainless steel deadlocking latch.
- **Projection:** 2-1/2" low profile for barrier-free access.
- **Material:** Heavy duty wrought steel chassis and pushpad: aluminum front and rear bar covers; stainless steel springs; nylon bearings.
- **Dogging:** Single point 1/4 turn dogging.
- **Cylinder:** Brass, 6-pin L4 keyway, 0-bitted.
- **Warranty:** Three-year limited.

Complete Devices

| Stock No. | Type of trim |
|------------|--------------------------------|
| RE-ED8200 | Exit Only |
| RE-ED8200B | Exit Only-Fire Rated-see below |

For complete device with trims not listed above order RE-ED8200 bar and the outside trim you need shown below. (EX: RE-ED8200 and RE-P850)

Trims (for complete device order with RE-ED8200)

| Stock No. | Type of trim |
|-----------|--------------------------------------|
| RE-F150 | Flat Plate-Dummy |
| RE-F157 | Flat Plate-Nightlatch w/rim cylinder |
| RE-G1055 | Global Knob-Classroom function |
| RE-N655 | Newport Lever-Classroom Function |
| RE-P850 | Wing Pull-Dummy |
| RE-P857 | Wing Pull-Nightlatch w/rim cylinder |

Finishes

For F150, G1055, N655 products:

- 612 Satin Bronze
- 613 Dark Oxidized Satin Bronze oil rubbed
- 626 Satin Chrome Plated

For ED8200, F157, P850, P857 products:

- 689 Silver Aluminum Painted
- 690 Dark Bronze Painted

Dogging Key

| Stock No. | Description |
|------------|--------------------------|
| RE-123F538 | Size: 3/16", dogging key |

RE-ED8200B 1-1/2 Hour Fire Rated Rim Exit Device
Complies with NFPA 80 Fire Doors. Warnock Hersey International(WHI)-rated for B label and lesser class 4' x 8' single or 8' x 8' double doors. Furnished with sex nuts and bolts. Dogging not available.

TO ORDER, SPECIFY

Stock No., Finish and Width (EX: RE-ED8200 689 36") AND OUTSIDE TRIM, IF NEEDED (EX: RE-N655 626)

RIM STRIKE SUPPLIED (386F45)



Standard strike supplied with ED8200

—OUTSIDE TRIM—

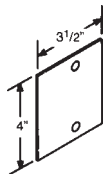

RE-F150 (Shown)
RE-F157 w/ rim cylinder

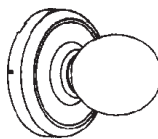

RE-G1055 w/key-in-knob cylinder



RE-N655 w/key-in-lever cylinder

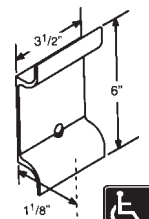

RE-P850 (Shown)
RE-P857 w/ rim cylinder

©ZIPF LOCK COMPANY

EXIT DEVICES



- ANSI A156.3, Type 2, Grade 1
- A117.1 Accessibility Code
- 3-year warranty

ED8400 Series

Vertical Rod Pushbar Exit Devices

▪ Heavy duty steel construction and Grade 1 performance, priced for outstanding value. Meets rigorous life safety and security requirements, while offering pleasing aesthetics and trouble-free operation. Designed for high-use, high-abuse situations, ED8000 Pushbar Exit Devices can be teamed with a variety of Corbin Russwin trims to provide desired functions, styles and finishes in new construction and renovations.

- **U.L.** listed for safety as panic hardware..
- **ANSI:** Meets A156.3, Type 2, Grade 1, and A117.1 Accessibility Code.
- **ADA:** Exit Devices, lever trims and pulls comply.
- **Handing:** Handed-SPECIFY hand LHR or RHR.
- **Fasteners:** Machine screws.
- **Bar Length:** Easily field cut to size. 36" bar fits 31" - 36" door;
- **Door Thickness:** 1-3/4".
- **Stile:** Minimum width 5".
- **Backset:** 2-3/4". Device and trim cover standard ANSI A115.2 (Type 161) cylindrical lock preparation.
- **Door Height:** All top rods easily field cut to size. Top rod for 7'6" door.
- **Projection:** 2-1/2" low profile for barrier-free access.
- **Latchbolts:** Top: 1/2" interlocking drop latch;
Bottom: 5/8" pivoted.
- **Vertical Rods:** Inverted U-shaped rectangular.
- **Material:** Heavy duty wrought steel chassis and pushpad: steel vertical rods; aluminum bar and latch covers; stainless steel springs; nylon bearings.
- **Dogging:** Single point 1/4 turn dogging.
- **Cylinder:** Brass, 6-pin L4 keyway, 0-bitted.
- **Warranty:** Three-year limited.

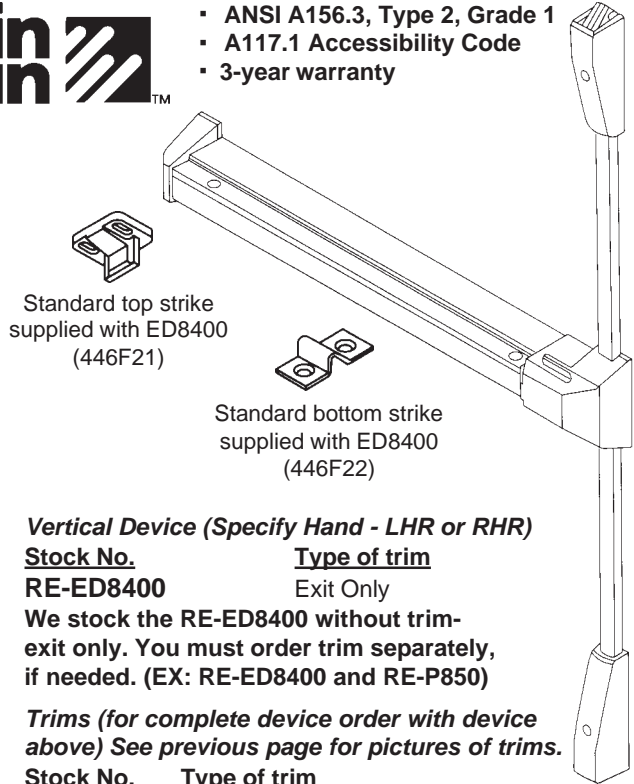

Standard top strike supplied with ED8400 (446F21)

Standard bottom strike supplied with ED8400 (446F22)

Vertical Device (Specify Hand - LHR or RHR)

| | |
|------------------|---------------------|
| <u>Stock No.</u> | <u>Type of trim</u> |
| RE-ED8400 | Exit Only |

We stock the RE-ED8400 without trim-exit only. You must order trim separately, if needed. (EX: RE-ED8400 and RE-P850)

Trims (for complete device order with device above) See previous page for pictures of trims.

| | |
|------------------|--------------------------------------|
| <u>Stock No.</u> | <u>Type of trim</u> |
| RE-F150 | Flat Plate-Dummy |
| RE-F157 | Flat Plate-Nightlatch w/rim cylinder |
| RE-G1055 | Global Knob-Classroom function |
| RE-N655 | Newport Lever-Classroom Function |
| RE-P850 | Wing Pull-Dummy |
| RE-P857 | Wing Pull-Nightlatch w/rim cylinder |

Strike for Inactive Door

| | |
|------------------|---------------------------------------|
| <u>Stock No.</u> | <u>Description</u> |
| RE-468F30 | Use on inactive door of pair of doors |

Finishes

For F150, G1055, N655 products:

- 612 Satin Bronze
- 613 Dark Oxidized Satin Bronze oil rubbed
- 626 Satin Chrome Plated

For ED8400, F157, P850, P857, 468F30 products:

- 689 Silver Aluminum Painted
- 690 Dark Bronze Painted

Dogging Key

| | |
|------------------|--------------------------|
| <u>Stock No.</u> | <u>Description</u> |
| RE-123F538 | Size: 3/16", dogging key |

**Need a Corbin
Russwin
Exit Device
not shown here??**

**Give us a call with
your needs**

1-800-848-1577

OPTIONAL STRIKE

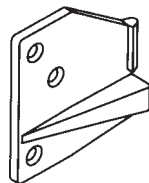

RE-468F30
Required for ED8200 devices when used on a pair of doors with ED8400 device.

HANDING

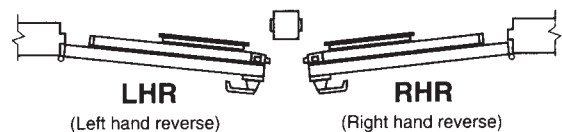

Outside